

BOSE[®]



Acoustimass[®] 6 series V
Acoustimass[®] 10 series V
home theater speaker systems

Important Safety Information

Please read this owner's guide and save it for future reference.



The lightning flash with arrowhead symbol within an equilateral triangle alerts the user to the presence of uninsulated, dangerous voltage within the system enclosure that may be of sufficient magnitude to constitute a risk of electric shock.



The exclamation point within an equilateral triangle, as marked on the system, is intended to alert the user to the presence of important operating and maintenance instructions in this owner's guide.



WARNINGS:

- To reduce the risk of fire or electrical shock, do not expose the product to rain or moisture.
- Do not expose this apparatus to dripping or splashing, and do not place objects filled with liquids, such as vases, on or near the apparatus. As with any electronic products, use care not to spill liquids into any part of the system. Liquids can cause a failure and/or a fire hazard.
- Do not place any naked flame sources, such as lighted candles, on or near the apparatus.



CAUTION:

- Do not make unauthorized alterations to the product; doing so may compromise safety, regulatory compliance, system performance and may void the warranty.



WARNING: This product contains magnetic material. Contact your physician if you have questions on whether this might affect the operation of your implantable medical device.

NOTES:

- Where the mains plug or appliance coupler is used as the disconnect device, such disconnect device shall remain readily operable.
- This product must be used indoors. It is neither designed nor tested for use outdoors, in recreation vehicles, or on boats.
- The speaker wire and interconnect cables included with the system are not approved for in-wall installation. Please check your local building codes for the correct type of wire and cable required for in-wall installation.



This symbol means the product must not be discarded as household waste, and should be delivered to an appropriate collection facility for recycling. Proper disposal and recycling helps protect natural resources, human health and the environment. For more information on disposal and recycling of this product, contact your local municipality, disposal service, or the shop where you bought this product.



Bose Corporation hereby declares that this product is in compliance with the essential requirements and other relevant provisions of Directive 1999/5/EC and all other applicable EU directive requirements. The complete declaration of conformity can be found at: www.Bose.com/compliance.

Important Safety Instructions

1. Read these instructions.
2. Keep these instructions.
3. Heed all warnings.
4. Follow all instructions.
5. Do not use this apparatus near water.
6. Clean only with a dry cloth.
7. Do not block any ventilation openings. Install in accordance with the manufacturer's instructions.
8. Do not install near any heat sources such as radiators, heat registers, stoves, or other apparatus (including amplifiers) that produce heat.
9. Protect the power cord from being walked on or pinched particularly at plugs, convenience receptacles, and the point where they exit from the apparatus.
10. Only use attachments/accessories specified by the manufacturer.
11. Unplug this apparatus during lightning storms or when unused for long periods of time.
12. Refer all servicing to qualified personnel. Servicing is required when the apparatus has been damaged in a way, such as power-supply cord or plug is damaged, liquid has been spilled or objects have fallen into the apparatus, the apparatus has been exposed to rain or moisture, does not operate normally, or has been dropped.

Names and Contents of Toxic or Hazardous Substances or Elements

Part Name	Toxic or Hazardous Substances and Elements					
	Lead (Pb)	Mercury (Hg)	Cadmium (Cd)	Hexavalent (CR(VI))	Polybrominated Biphenyl (PBB)	Polybrominated diphenylether (PBDE)
PCBs	X	0	0	0	0	0
Metal parts	X	0	0	0	0	0
Plastic parts	0	0	0	0	0	0
Speakers	X	0	0	0	0	0
Cables	X	0	0	0	0	0

0: Indicates that this toxic or hazardous substance contained in all of the homogeneous materials for this part is below the limit requirement in SJ/T 11363-2006.

X: Indicates that this toxic or hazardous substance contained in at least one of the homogeneous materials used for this part is above the limit requirement in SJ/T 11363-2006.

Please complete and retain for your records.

The serial number and model number are located on the connector panel of the Acoustimass® module.

Serial Number: _____

Model Number: _____

Purchase date: _____

Please keep your receipt together with this owner's guide.

Blu-ray Disc™ and "Blu-Ray™" are trademarks of the Blu-Ray Disc Association.

HDMI is a trademark or registered trademark of HDMI Licensing LLC in the United States and other countries.

©2014 Bose Corporation. No part of this work may be reproduced, modified, distributed, or otherwise used without written permission.

Introduction

Thank You 4
 Unpacking the carton 4

Setting Up

Placing your speakers to achieve realistic home theater sound..... 5
 Front left and right speakers..... 6
 Center speakers 6
 Rear speakers..... 6
 Powered Acoustimass® module..... 6
 Making the connections 7
 Connecting speakers to the Acoustimass module 7
 Connecting the Acoustimass® module to the receiver 8
 Checking the connections 9

Using Your System

Getting the most from your home theater speakers..... 10
 Adjusting the bass/room compensation..... 10
 Adjusting the LFE level 10
 Setting your digital surround sound receiver 11
 Receiving a digital audio signal 11
 Setting your analog surround sound receiver 11

Reference

Troubleshooting 12
 Customer service..... 13
 Cleaning..... 13
 Limited warranty information..... 13
 Accessories 13
 Technical Information..... 14
 Speaker driver complement..... 14
 System power rating 14
 Connectivity 14

Introduction

Thank You

We appreciate your choice of the Bose® Acoustimass® 6 series V or Acoustimass 10 series V home theater speaker system.

The Acoustimass 6 features five small cube speakers, while the Acoustimass 10 system features four cube speaker arrays and a center front speaker. These speakers, together with the Acoustimass module, produce a powerful and realistic home theater experience.

Unpacking the carton

Carefully unpack the carton contents:

1. Remove the brown inner carton containing the speakers.
2. Gently roll the carton onto its side and pull out the Acoustimass module.

WARNING: To avoid injury, use care in lifting the module, which weighs roughly 30 lb (14 kg).

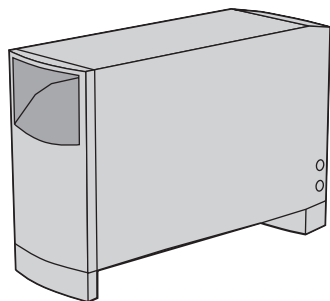

Powered acoustimass module

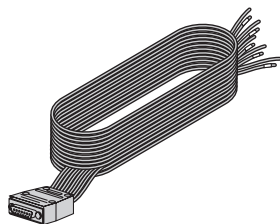

20-ft (6.1 m) system input cable

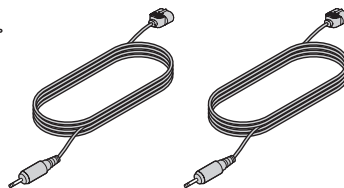

Three 20-ft (6.1 m) front speaker cables

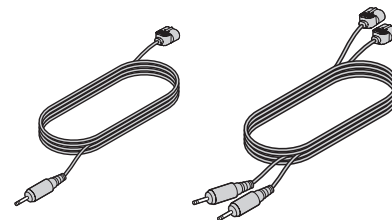

Two 50 ft (15.2 m) rear speaker cables

With Acoustimass 6 system

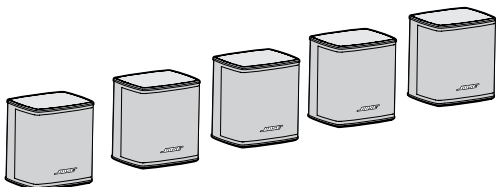

Five Virtually Invisible® series II speakers

With Acoustimass 10 system

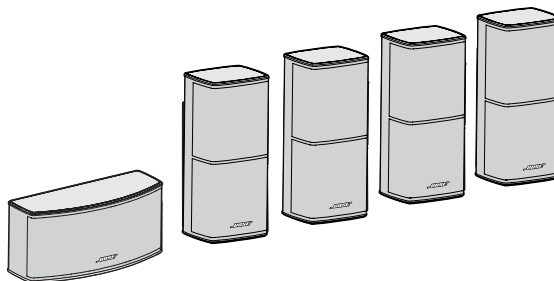

Four Direct/Reflecting® series II speakers and one horizontal center channel speaker

Power cord (1)



U.S./Canada



Europe



U.K./Singapore



Australia

Now is a good time to record the serial number for your product on your warranty card. Save all packaging materials for possible future use.

WARNING: To avoid danger of suffocation, keep the plastic bags that wrap these speakers out of the reach of children.

Placing your speakers to achieve realistic home theater sound

Keep these guidelines in mind when choosing a location for each speaker:

- The Acoustimass® module should be at least 2 feet (.6 m) from your TV set to prevent interference.
- Select a stable and level surface for each of the speakers.
- In an Acoustimass 10 system, the center channel speaker is for use at the front of the room and near the center of your TV. The other speakers are identical and can be placed interchangeably around the room.
- In the Acoustimass 6 system, all five speakers are identical and can be placed interchangeably around the room.
- The shape and size of your room and location of the furniture in it will affect your choice of speaker locations. Use the example below as a guideline for your home theater setup.

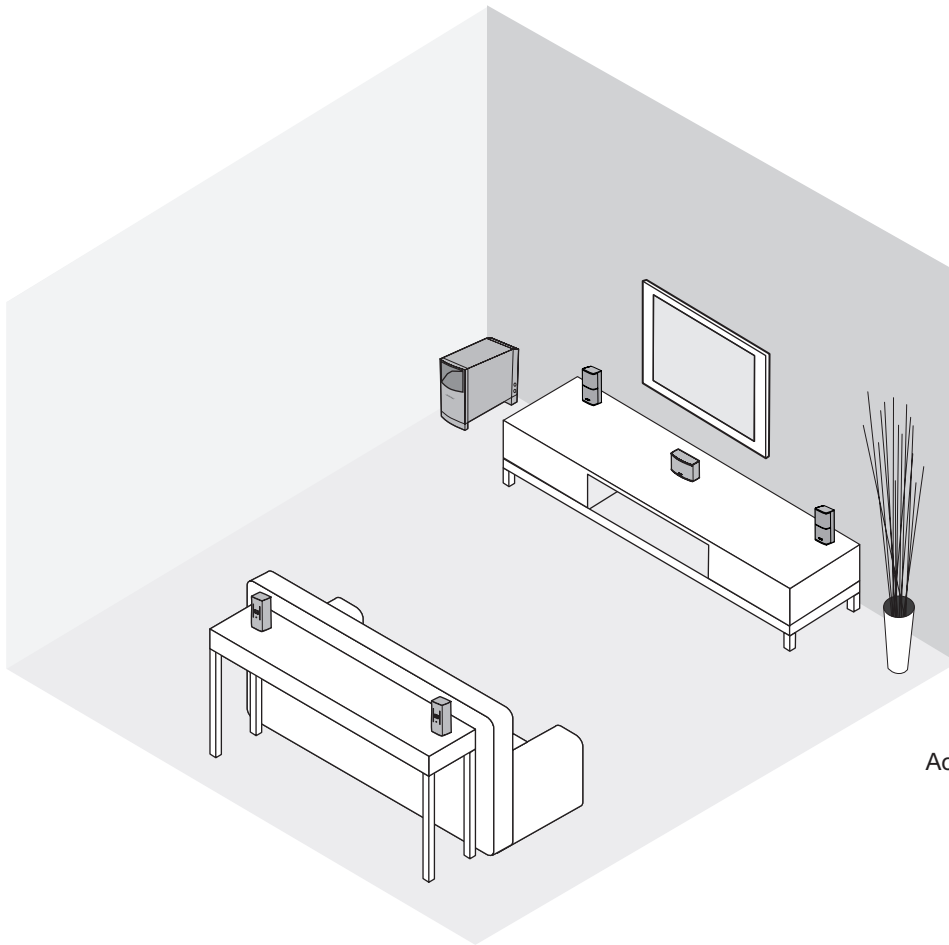

Acoustimass 10 series V system

Setting Up

Front left and right speakers

The goal for these is to create a sound image wider than the screen that seems natural to viewers sitting anywhere in the room.

- Place these two front speakers on either side of your TV.
- Keep them 6 feet (2 m) to 15 feet (5 m) apart and at least 6 inches (15 cm) away from any CRT (picture tube) TV.

Center speaker

Sound from the center speaker should seem to come from within the picture to give the most realistic performance of on-screen action and dialogue.

- Place the center speaker above, on top of, or below your TV. Do NOT rest the weight of the TV on the speaker.
- Keep the speaker in line with the vertical center of the screen, if possible, for the most accurate reproduction of dialogue.
- Keep the speaker at least 6 inches (15 cm) away from any CRT (picture tube) TV.

Rear speakers

While the rear (surround) speakers may deliver some dialogue, they serve primarily to deliver discrete sounds and special effects that expand the visual image. They help bring the viewer into the center of the action.

Choose locations that are practical and convenient, while considering these recommended guidelines:

- Position the left and right rear speakers so they can deliver sound on both sides of the viewer, rather than from directly behind.
- Place these speakers at the same height as the ears of a seated viewer or higher.

Powered Acoustimass® module

Acoustimass speaker technology makes it difficult to locate the source of low-frequency sound from this module. So feel free to hide it from view. Place the module according to the following guidelines:

- At the same end of the room as the TV screen.
- At least 2 feet (.6 m) from your TV set to prevent interference.
- To increase bass effects, turn the front opening toward a wall; turn it away from the wall to decrease bass effects.
- Keep both the front opening and the ventilation grille on the bottom of the module at least 2 inches (5 cm) from any other surface.
- Do not block the ventilation grilles located on the bottom of the module. Impeding ventilation can cause a reduction in the bass-frequency output from the module.

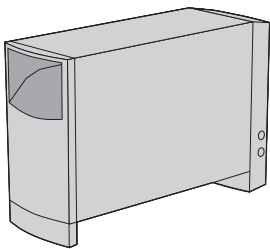

Preferred

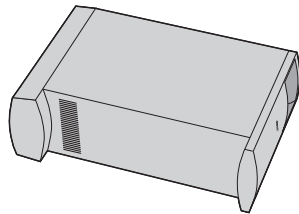

Alternate

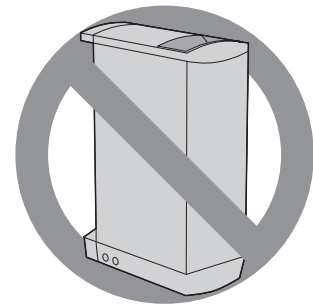

Making the connections

Only the Acoustimass® module connects to your receiver. The speakers all connect directly to the Acoustimass module.

WARNING: Do not connect the speakers to a receiver. This can result in damage to your system and possible electric shock.

Connecting speakers to the Acoustimass module

Insert the plug on each speaker cable into the connector on the module. Match the label on the plug to the proper connector.

1. Use the supplied 20-ft (6.1 m) speaker cables for the three front speakers.
 - Insert the **R** plug into the connector labeled **Right Front**.
 - Insert the **C** plug into the connector labeled **Center Front**.
 - Insert the **L** plug into the connector labeled **Left Front**.
2. Use the supplied 50-ft (15.2 m) speaker cables for the speakers at the rear of your room.
 - Insert the **RR** plug into the connector labeled **Right Rear**.
 - Insert the **LR** plug into the connector labeled **Left Rear**.
3. Insert the other end of each cable into the connector on each speaker, with the label facing down.

Note: Find the label on each speaker cable that matches it to the proper speaker:

Speaker cable label	
L for the speaker at the left front	LR for the speaker at the left rear
R for the speaker at the right front	RR for the speaker at the right rear
C for the speaker at the center front	

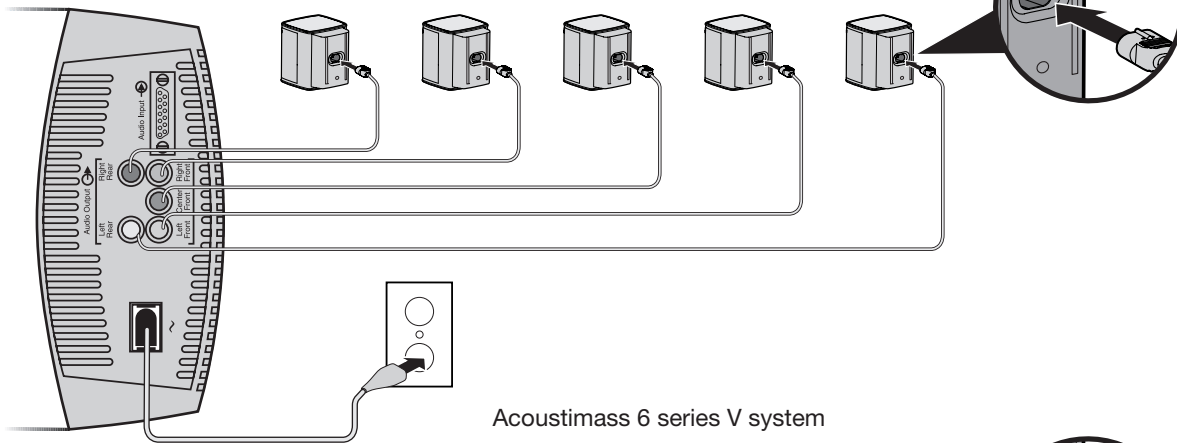

Acoustimass 6 series V system

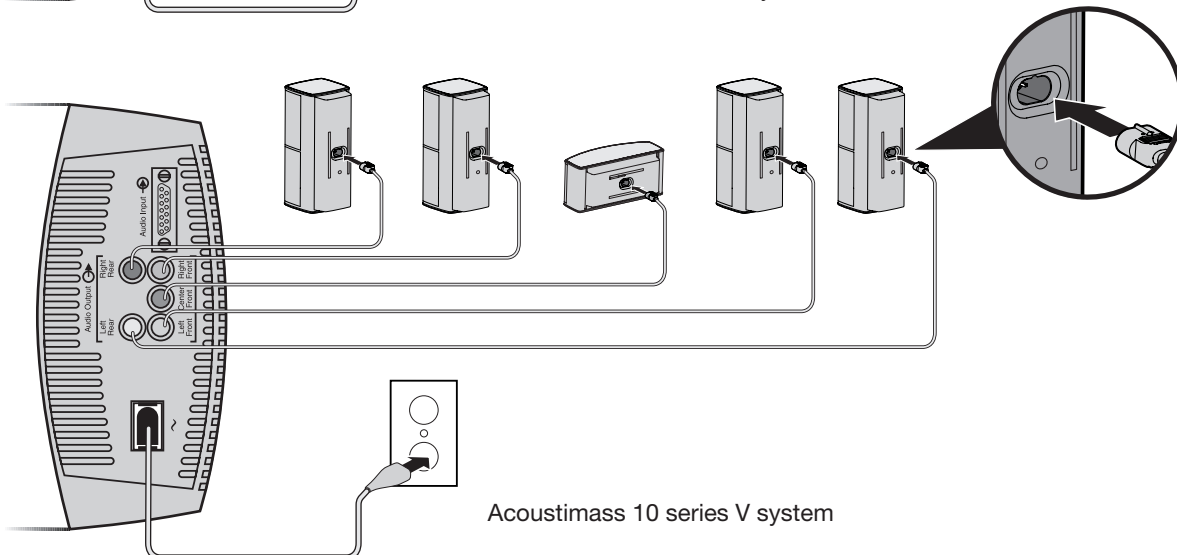

Acoustimass 10 series V system

Setting Up

Connecting the Acoustimass® module to the receiver

CAUTION: Before making these connections, turn off your receiver to prevent unwanted noises when you plug the Acoustimass® module into it.

The system input cable is 20 feet (6.1 m) long and connects to your surround receiver. Unlike the speaker cables, this input cable has a multi-pin connector that inserts into the **Audio Input** connector on the module.

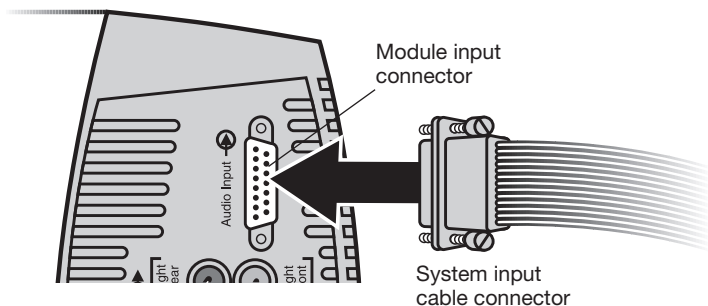

At the other end of the system input cable, multiple wire pairs “unzip” for easy reach and insertion into terminals on your receiver. A red collar marks a wire as positive (+) wire.

CAUTION: Do NOT connect your module to the TV, which lacks the required amplification.

The single RCA plug at that end is for use ONLY with a receiver that handles low-frequency effects and provides an **LFE/SUBWOOFER** connector.

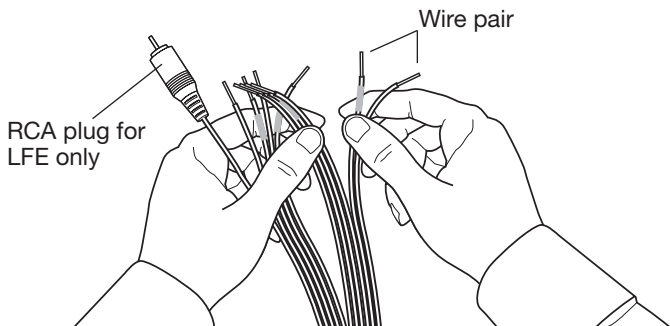

To make the connections:

1. Insert the multi-pin connector on the system input cable into the input connector on the Acoustimass® module. Tighten the two thumbscrews to secure the connection.
2. Connect each wire pair on the other end of the system input cable to your surround receiver, which should have audio output terminals labeled:
 - Right, Left, and Center for the front audio channels.
 - Right Surround and Left Surround for the rear channels. The specific labels on your receiver may differ slightly.

CAUTION: Do not allow exposed wires to brush against each other; this could damage your receiver.
3. Carefully match the polarity of the connections (+ to + and – to –).
 - Attach each red-collared wire (+) to the appropriate + terminal.
 - Attach each plain wire (–) to the appropriate – terminal.
4. If applicable to your receiver, insert the RCA plug marked **LFE** on the system input cable into the **LFE/SUBWOOFER OUT** connector on your surround receiver. Remove the cover first.

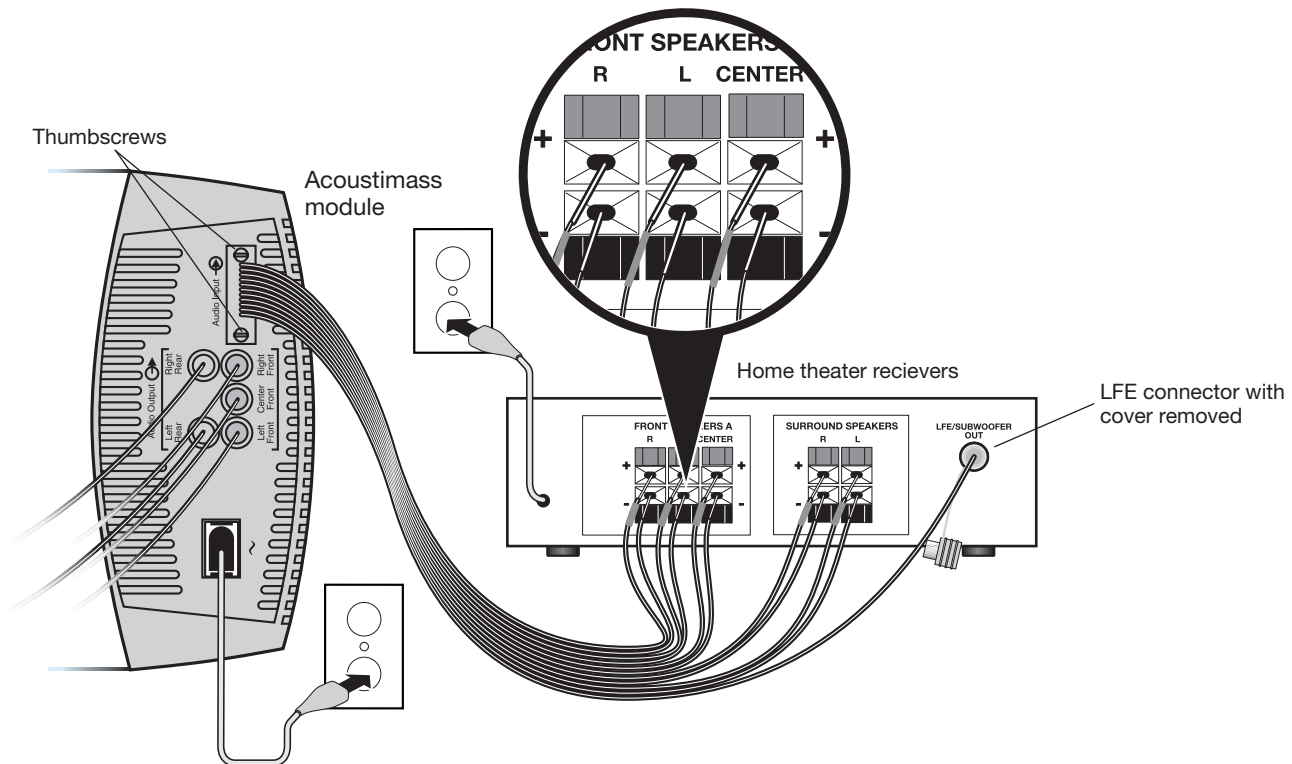

Checking the connections

Before plugging in the Acoustimass module, check all connections from the receiver to the module and the module to the speakers.

- Make sure all speakers are connected to the proper terminals according to their position in your room.
- Check to be sure all wires are connected to your surround receiver with the proper polarity (+ to + and – to – wires). Incorrect wiring can result in a total loss of module output.
- Correct any wiring problems before you plug in your receiver and turn it on.

When all the connections check out, plug the power cord from the Acoustimass module into an AC (mains) outlet. Plug in the receiver also.

Note: Bose recommends using a quality surge suppressor on all electronics equipment. Voltage variations and spikes can damage electronic components in any system. Using a high-quality suppressor (available at electronics stores) can eliminate the vast majority of failures caused by a power surge.

Using Your System

Getting the most from your home theater speakers

With system connections completed and the module plugged in, your Acoustimass® system is now ready for use.

Familiarize yourself with the controls and built-in protections that adjust the audio of this system. They offer options to suit your particular style of use and preferences.

CAUTION: This system provides an automatic protection circuit to help guard against damage from electrical stresses and overload of the system. At high volume levels, the circuit activates to reduce output, which slightly decreases the volume. If you notice this decrease, be aware that your system is functioning as designed. This volume reduction also indicates that power input to the system may exceed safe levels. Sustained listening at these levels is not recommended.

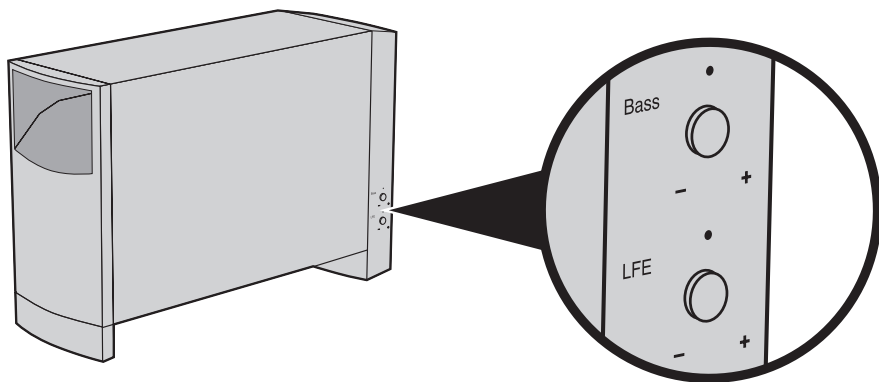

Adjusting the bass/room compensation

After placing the Acoustimass module where you want it, you can fine-tune it for that location. Make this adjustment only as necessary.

For example:

- If the system performance lacks bass, turn the BASS control (shown above) clockwise to increase the low-frequency output of the module.
- If the audio overemphasizes bass, turn the knob counter-clockwise to reduce the low-frequency output of the module.

The setting made at the factory is meant for use in the most common room arrangements.

Adjusting the LFE level

The LFE level control (shown above) is for use only with receivers that provide an LFE/SUBWOOFER channel.

By turning the knob, you can adjust the relative level of the low-frequency effects from movie soundtracks. Use it to match the volume level of the LFE channel with volume levels of your other speaker channels.

You can check all levels by using the “test tones” feature on your digital surround sound receiver. For details on using this feature, refer to the owner’s guide provided with your surround receiver.

Setting your digital surround sound receiver

Speakers in your Acoustimass® 6 series V or Acoustimass 10 series V system are fully compatible with the audio output of digital surround receivers. The system's integrated signal processing supports full low-frequency reproduction from all channels.

To gain complete advantage of these system capabilities, you may want to adjust some settings on your receiver. To make changes, use the digital display menu on the receiver and refer to the list of recommended settings below.

Speaker	Receiver setting
Left and right	LARGE
Center	LARGE
Left and right surround	LARGE
LFE/Subwoofer	ON

Note: If your receiver provides it, the LFE or Subwoofer option setting should be ON and the crossover value at the lowest number possible, which is typically 80 Hz.

Receiving a digital audio signal

For the digital audio signal from additional sources (Blu-ray™ or DVD player, CBL/SAT box, gaming system, etc.) to reach your surround receiver, you need a digital audio connection between the additional source and receiver.

- Use either the HDMI™, Optical or Coaxial input on the receiver to connect to the digital output from the additional source. Do not use more than one connection.
- Be sure to select the digital output in the setup menu of your additional source.

For additional setup and operating information, please refer to the owner's guide that came with your surround receiver.

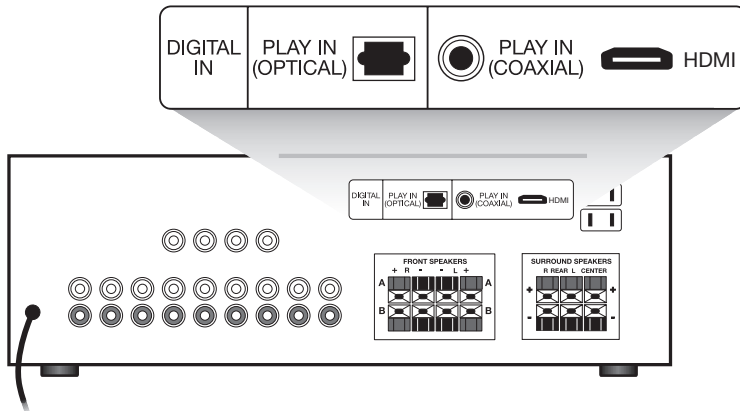

Setting your analog surround sound receiver

For analog (non-digital) surround sound applications, we recommend that you set the surround sound center mode of your receiver to Wide. For instructions on how to change this setting, refer to the owner's guide provided with your surround receiver.

Reference

Troubleshooting

If you have a problem with your Acoustimass® speaker system, turn off your sound source and try the following solutions. If you still have a problem, contact your Bose® dealer to arrange for service. To contact Bose directly, refer to the contact sheet in the carton.

Problem	What to do
System does not function at all	<ul style="list-style-type: none">• Make sure the receiver and powered Acoustimass module are plugged into an operating AC outlet and that the receiver is turned on.• Be sure to select an audio source on the receiver (Blu-ray or DVD player, CBL/SAT box, gaming system, etc.).
No sound	<ul style="list-style-type: none">• Increase the volume.• Disconnect any headphones.• Check the speaker connections at the bass module, receiver, and speakers.• Make sure that both the powered Acoustimass module and the receiver are plugged in.• For digital sound, be sure an HDMI, coaxial or optical cable connects the digital output of the audio source with the digital input on your receiver.• Be sure the audio source selected is correct. For example, select DVD audio on your receiver to hear the DVD sound.
No surround sound	<ul style="list-style-type: none">• Make sure the source material contains surround sound.• If you are using the Dolby Pro-Logic mode on your receiver, make sure surround sound is turned on.• Be sure the source material (Blu-ray™ or DVD player, CBL/SAT box, gaming system, etc.) is Dolby Digital encoded.• Be sure your receiver is processing a signal from a stereo TV, laserdisc, Blu-ray player or DVD player, or other surround sound source.• If you are using digital programming, verify that the settings are correct at the receiver.
No bass	<ul style="list-style-type: none">• Be sure the speaker connections from the receiver to the amplifier are in the correct phase, red-collared wire to red connector (+ to + and – to –).• Verify that the speaker size in the receiver is set to large.
Not enough or too much bass	<ul style="list-style-type: none">• Move your Acoustimass module closer to a wall or corner to increase bass. Move it farther from a wall or corner to decrease bass.• Adjust the LFE level or Room Compensation control.
Sound is distorted	<ul style="list-style-type: none">• Make sure speaker wire is not damaged.• Reduce the volume of external components connected to the receiver.

Customer service

For additional help in solving problems, contact the Bose® Customer Service office appropriate to your area. See the contact sheet in the carton.

Cleaning

The cabinets of your Acoustimass® speaker system may be cleaned only with a soft dry cloth. Do not use any sprays near the system or allow liquids to spill into any openings. Also, do not use any solvents, chemicals, or cleaning solutions containing alcohol, ammonia, or abrasives.

The grille assemblies on the speakers may be carefully vacuumed, if necessary. Please note that the drivers are located directly behind the grille and are easily damaged if reasonable care is not taken.

Limited warranty information

Your Acoustimass® speaker system is covered by a limited warranty. Details of the warranty are provided on the warranty card that came with your system. Please fill out the information section on the card and mail it to Bose. Failure to do so, however, does not affect your rights.

The warranty information provided with this product does not apply in Australia or New Zealand. See our website at www.bose.com.au/warranty or www.bose.com.nz/warranty for details of the Australia and New Zealand warranty.

Accessories

You can place system speakers on wall brackets, table stands or floor stands. To purchase these accessories, contact your local Bose® dealer or visit www.Bose.com.

For the following accessories:

- Input cable adapter for use with in-wall wiring from the Acoustimass module to the receiver
- 20-ft (6.1 m) extension cable for use between the Acoustimass module and the receiver
- Speaker cable adapters for use with in-wall wiring

Contact your authorized Bose dealer. Or to contact Bose directly, refer to the contact sheet in the carton.

Speaker driver complement

Acoustimass® 10 system:

- Cube speaker arrays and center front speaker:
Two 2.5" (6.35 cm) Twiddler™ speakers
- Powered Acoustimass module:
Two 5.25" (13 cm) woofers

Acoustimass 6 system:

- Cube speakers:
One 2.5" (6.35 cm) Twiddler™ speaker
- Powered Acoustimass module:
One 5.25" (13 cm) woofers

System power rating

Acoustimass 10 system:

U.S./Canada: 100-127V ~ 50/60 Hz 270W

Europe/Australia: 220-240V ~ 50/60 Hz 270W

Acoustimass 6 system:

U.S./Canada: 100-127V ~ 50/60 Hz 135W

Europe/Australia: 220-240V ~ 50/60 Hz 135W

Connectivity

Acoustimass 10 system:

Compatible with A/V receivers and amplifiers rated from 10 to 200 watts per channel, rated from 4 to 8 ohms

Acoustimass 6 system:

Compatible with A/V receivers and amplifiers rated from 10 to 150 watts per channel, rated from 4 to 8 ohms

Acoustimass 10 system:

Cube speaker array and center front speaker: 2.2 lb (1kg) each

cube speaker array: 7.4"H x 3.2"W x 3.3"D (15.7 cm x 7.9 cm x 10.2 cm)

center front speaker: 3.4"H x 7.3"W x 3.2"D (15.7 cm x 7.9 cm x 10.2 cm)

Module: 35 lb (15.8 kg)

16.3"H x 8.1"W x 25.3"D (41.4 cm x 20.6 cm x 64.3 cm)

Acoustimass 6 system:

Cube speaker: 1.18 lb (0.45 kg) each

3.7"H x 3.2"W x 3.3"D (9.5 cm x 8.3 cm x 8.4 cm)

Module: 27 lb (12.2 kg)

16.3"H x 8.1"W x 22.3"D (41.4 cm x 20.6 cm x 56.6 cm)



717625-0010

BOSE[®]
Better sound through research[®]
©2014 Bose Corporation, The Mountain,
Framingham, MA 01701-9168 USA
AM717625 Rév. 00