

# DENON

## AVR-X1000

INTEGRATED NETWORK AV RECEIVER

# Getting Started

ENGLISH

FRANÇAIS

ESPAÑOL

Mise en route/ Antes de empezar

# Welcome

Thank you for choosing a Denon AV receiver. This guide provides step-by-step instructions for setting up your AV receiver.

## If you have setup problems:

If you need additional help in solving problems, contact Denon customer service in your area.

### **1-855-MY.Denon**

1-855-693-3666

Call for Assistance: 9:00AM to 8:00PM M-F E.S.T.

For frequency asked questions please visit





[www.usa.denon.com/FAQ](http://www.usa.denon.com/FAQ)

---

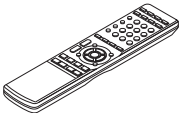

For US and Canada only

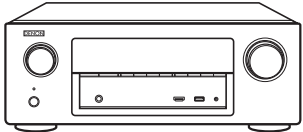
# Before You Begin

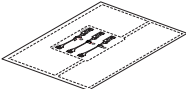
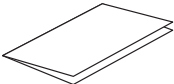
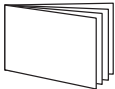
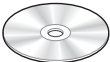
## What's In the Box

 <p>Setup and measurement microphone</p>	 <p>Remote control unit</p>	 <p>R03/AAA batteries</p>	
 <p>Receiver</p>		 <p>Power cord</p>	
 <p>Cable label</p>	 <p>Safety Instructions</p>	 <p>Getting Started</p>	 <p>Owner's Manual</p>

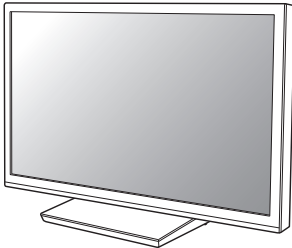
## Required for setup

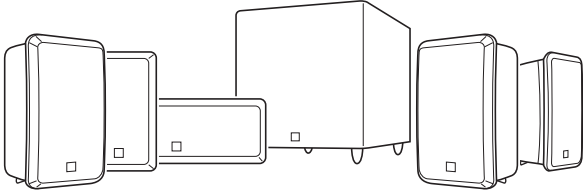
 <p>TV</p>	 <p>HDMI cable</p>
 <p>Speaker systems</p>	



These drawings are for illustrative purposes only and may not represent the actual product(s).

# Setup

There are three steps to the setup process.

- 1** Install batteries in the remote control unit
- 2** Connect the receiver to your TV
- 3** Follow the On-Screen Setup Assistant

## **1** Installing batteries in the remote control unit

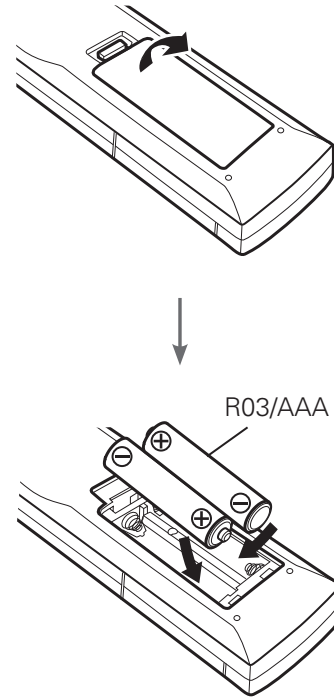

## 2 Connecting the receiver to your TV

❑ Place the receiver near your TV.

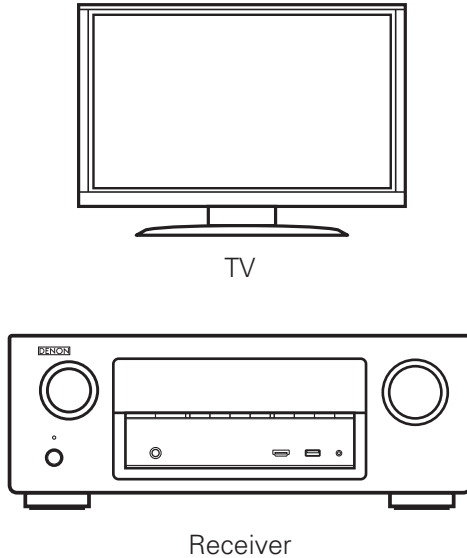

❑ Connect the receiver to your TV with an HDMI cable.

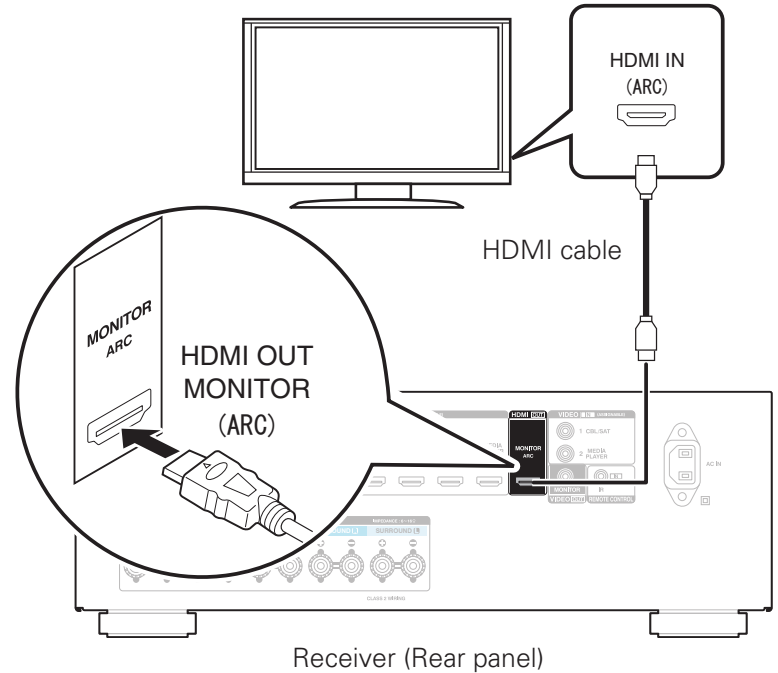

❑ Turn on the TV.

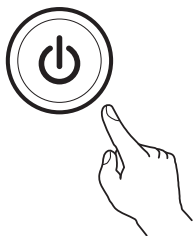
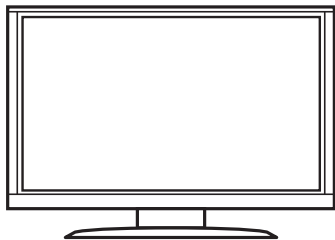

TV remote control unit

❑ Select the appropriate HDMI input on your TV.

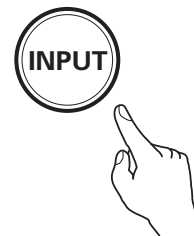
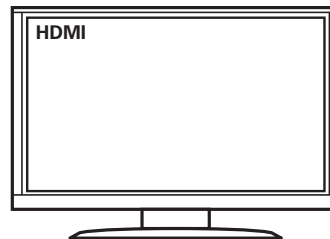

TV remote control unit

## ❑ Turn on receiver.

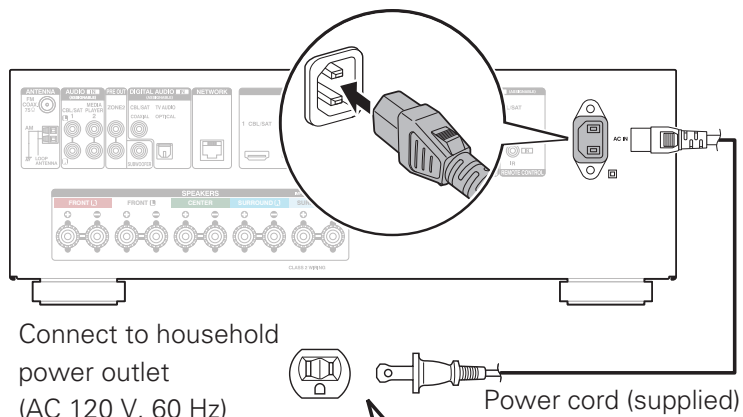

- Turn on receiver as shown below.

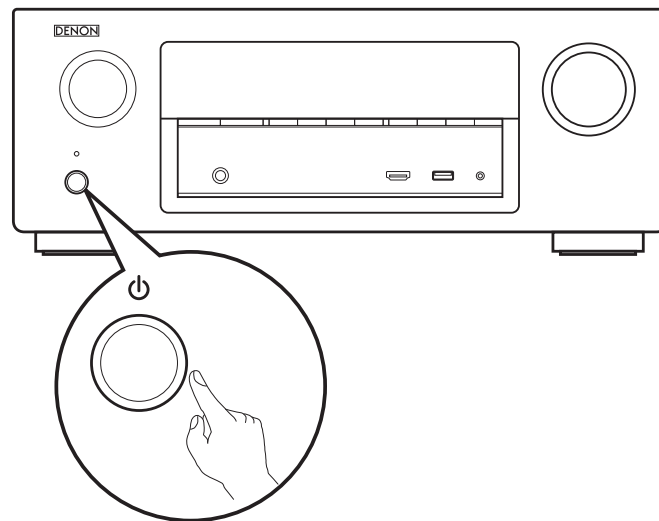

### 3 Follow the On-Screen Setup Assistant

The Setup Assistant will walk you through connecting and configuring your speakers and components to your Denon receiver. Please use the remote control and follow the on-screen instructions.

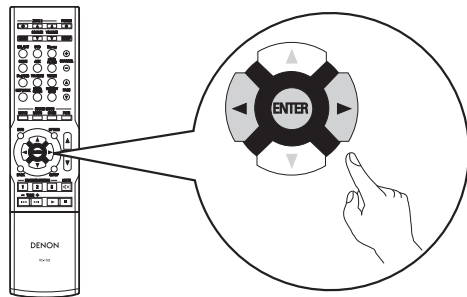
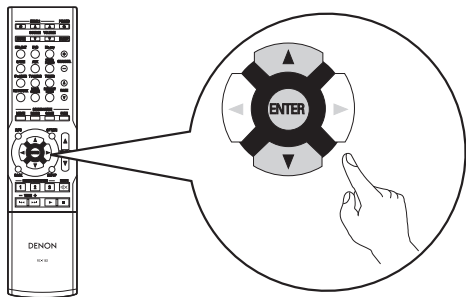
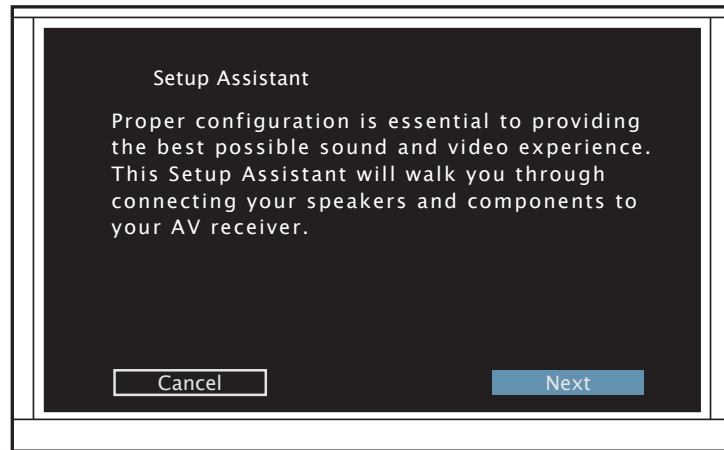
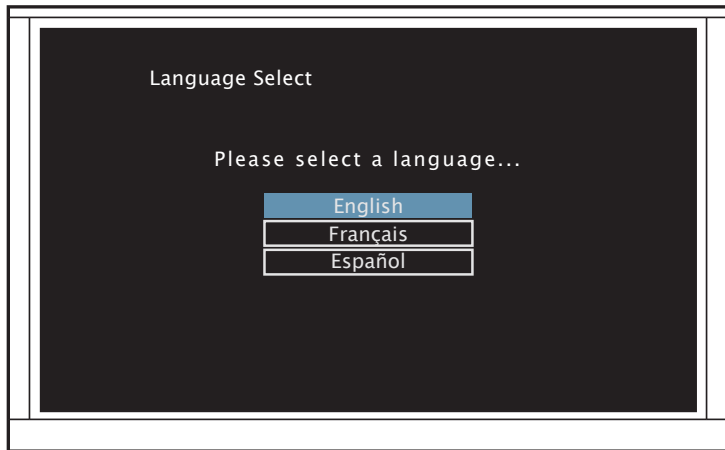



# Owner's Manual

The included CD-ROM contains an Adobe PDF version of the full owner's manual for the AV receiver. Please reference this manual for more details about the setup and operation of the receiver and its features.

## 1 Insert the disc into your PC.

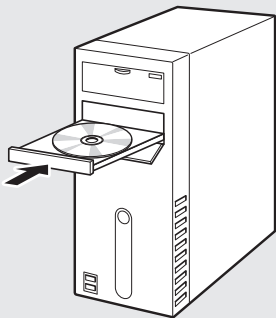

## 2 Follow the screen or double click on the PDF file.

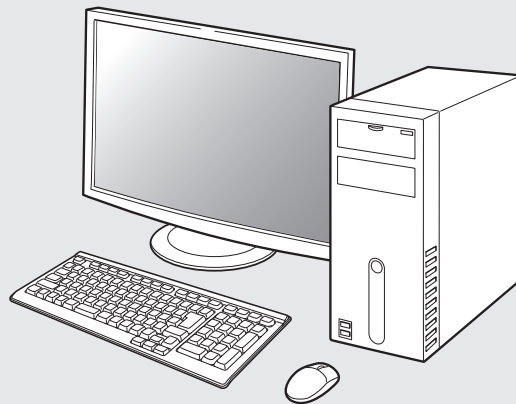

Product Name : Integrated Network AV Receiver  
Model Number : AVR-X1000

**DENON**

[www.denon.com](http://www.denon.com)

D&M Holdings Inc.  
Printed in China 5411 11010 00AD