

English



Information to consumers in application of EU WEEE Directive 96/2002

This product is subject to European Union regulations that promote the re-use and recycling of used electrical and electronic equipment. This product required the extraction and use of natural resources and may contain hazardous substances. The symbol above, on the product or on its packaging, indicates that this product must not be disposed of with your other household waste. Instead, it is your responsibility to dispose of your waste equipment by handing it over to a designated collection point for the recycling of waste electrical and electronic equipment. The separate collection and recycling of your waste equipment at the time of disposal will help to conserve natural resources and ensure that it is recycled in a manner that protects human health and the environment. For more information about where you can drop off your waste equipment for recycling, please contact your local city office, your household waste disposal service, or the store from which you purchased the product. For more information about Monster products, please visit us at: www.MonsterCable.com.

Français



Informations destinées aux consommateurs conformément à la Directive Européenne 96/2002 concernant les Déchets d'Équipements Électriques et Électroniques (DEEE)

Ce produit est soumis aux règles en vigueur dans l'Union Européenne promouvant la réutilisation et le recyclage des déchets d'équipements électriques et électroniques. Ce produit a requis l'extraction et l'utilisation de ressources naturelles et peut contenir des substances dangereuses. Le symbole ci-dessus, apposé sur le produit ou sur son emballage, indique que ce produit ne peut être jeté avec votre déchet ménager. Au contraire, il est de votre responsabilité de traiter vos déchets d'équipements en les remettant à un centre de collecte des déchets chargé du recyclage des déchets d'équipements électriques et électroniques. La reprise et le recyclage séparés de vos déchets d'équipements au moment de la mise au rebut aideront à conserver les ressources naturelles et à assurer qu'ils soient recyclés d'une manière protégeant la santé publique et l'environnement. Pour obtenir de plus amples informations au sujet de l'endroit de reprise et de collecte de vos déchets d'équipements pour le recyclage, veuillez vous adresser au bureau compétent de votre commune, à la société de collecte des déchets ou directement auprès du magasin où vous avez acheté le produit en question. Pour obtenir de plus amples informations sur les produits Monster, veuillez visiter notre site à l'adresse suivante: www.MonsterCable.com.

Nederlands



Informatie voor de consumenten in uitvoering van de Europese Richtlijn 2002/96/EG inzake afgedankte elektrische en elektronisch apparatuur (AEEA).

Dit product valt onder het toepassingsgebied van de Europese richtlijnen die het hergebruik en de recycling van gebruikte elektrische en elektronische apparaten promoten. Het product vereist de ontginning en gebruik van natuurlijke bronnen en kan gevaarlijke stoffen bevatten. Het hierboven of afgebeelde symbool op het product of op de verpakking, geeft aan dat het niet mag worden weggegooid met het gewone huisvuil. In plaats daarvan is het uw verantwoordelijkheid uw afgedankte apparaat af te leveren op een verzamelpunt voor recycling van elektrische en elektronische apparaten. De gescheiden inzameling en recycling van afgedankte apparaten draagt bij tot het behoud van natuurlijke bronnen en tot het hergebruik van materiaal op een manier die de volksgezondheid en het leefmilieu beschermt. Voor meer informatie over waar u uw afgedankte apparatuur kunt inleveren voor recycling, kunt u contact opnemen met de gemeente, het uw huishoudelijke afvalophaaldienst of de winkel waar u het product heeft aangeschaft. Voor meer informatie met betrekking tot producten van Monster, kunt u terecht op de website www.MonsterCable.com.

Español



Información al consumidor en aplicación de la Directiva Comunitaria RAEE 96/2002 (sobre Residuos de Aparatos Eléctricos y Electrónicos)

Este producto está sujeto al reglamento de la Unión Europea que promueve la reutilización y reciclaje de aparatos eléctricos y electrónicos usados. Este producto puede contener sustancias peligrosas, y la extracción y utilización de recursos naturales fue necesaria para su fabricación. El símbolo que aparece al inicio, si figura en el producto o en su envase, indica que este producto no debe eliminarse junto con el resto de sus residuos domésticos. Así que es responsabilidad de los consumidores deshacerse de sus aparatos depositándolos en un punto de recogida designado para el reciclaje de aparatos eléctricos o electrónicos. La recogida selectiva y reciclaje de los residuos de sus aparatos en el momento de su eliminación contribuye a la conservación de los recursos naturales y garantiza su reciclaje de forma que se proteja la salud de las personas y el medio ambiente. Para obtener más información sobre los puntos de recogida de residuos eléctricos y electrónicos para su reciclaje, póngase en contacto con su ayuntamiento, con el servicio de eliminación de residuos domésticos, o con el establecimiento en el que adquirió el producto. Para obtener más información sobre los productos Monster, visite nuestra página web: www.MonsterCable.com.

Italiano



Informazioni al consumatore in applicazione della Direttiva UE WEEE 96/2002

Questo prodotto è soggetto alla regolamentazione europea che promuove il recupero ed il riciclo di apparecchi elettrici ed elettronici usati. Questo prodotto richiede l'estrazione e l'impiego di risorse naturali e può contenere sostanze pericolose. Il simbolo sopra, posto sul prodotto stesso o sull'imballaggio, indica che il prodotto non può essere gettato assieme agli altri rifiuti comuni. Al contrario, è responsabilità del consumatore eliminare

il prodotto consegnandolo ad un punto di raccolta designato per il riciclo di apparecchi elettrici ed elettronici. La raccolta separata ed il riciclo di questo rifiuto elettrico, al momento della raccolta, aiuterà a conservare le risorse naturali e ad assicurare un corretto riciclo, al fine di preservare la salute umana e l'ambiente. Per maggiori informazioni circa dove consegnare i rifiuti elettrici ai fini del riciclo, si prega di contattare l'ufficio della propria città, il servizio di gestione di rifiuti, o il negozio dove si è acquistato il prodotto. Per maggiori informazioni sui prodotti Monster, si prega di visitare il sito: www.MonsterCable.com.

Polski



Informacja dla konsumentów w związku z obowiązywaniem Dyrektywy 2002/96/WE

Niniejszy produkt podlega regulacjom prawnym Unii Europejskiej promującym ponowne użycie i recykling tego sprzętu elektrycznego i elektronicznego. Wytworzenie produktu wymagało skorzystania z surowców naturalnych naszej planety; ponadto, produkt może zawierać substancje niebezpieczne. Symbol umieszczony powyżej, na produkcie, oraz na jego opakowaniu, wskazuje, że ten produkt nie może być wyrzucony wraz z innymi odpadami i nie należy go wyrzucać do gospodarstwa domowego, przeciwnie: jako nabywca i użytkownik, są Państwo odpowiedzialni za przekazanie tego produktu do wyspecjalizowanego punktu zbierania zużytego sprzętu elektrycznego i elektronicznego. Selekcjonowanie sprzętu już w momencie zakupu jego użycia oraz późniejszy recykling sprzętu przyczyniają się do zachowania surowców naturalnych i zapewnienia, że zużyty sprzęt elektryczny i elektroniczny podlega bieżącej recyklingowi prowadzonemu w sposób bezpieczny dla zdrowia ludzi oraz przyjazny dla środowiska. W celu uzyskania informacji o adresach punktów, do których można przekażać zużyty sprzęt elektryczny i elektroniczny, prosimy o skontaktowanie się ze swoim urzędem gminy lub miasta, przedsiobiorstwem zajmującym się wywozem śmieci, albo ze sklepem, w którym sprzedany został niniejszy produkt. W celu informacji o produktach Monster mogą Państwo uzyskać na stronie: www.MonsterCable.com.

Magyar



Felhasználói tájékoztató az Elektronikus és Elektronikai Hulladékokról szóló 96/2002/EK Irányelv alkalmazásáról

Ez a termék az Európai Unió használt elektronikus és elektronikai készülékek újrahasználatának és újrahasznosításának előmozdítását célzó rendelkezéseinek hatálya alá esik. Ez a termék természeti erőforrások kitermelését és felhasználását igényelte és veszélyes anyagokat tartalmazhat. A fenti jel, mely a terméken vagy annak csomagolásán szerepel, azt jelöli, hogy a terméket tilos egyéb háztartási hulladékkal együtt kidobni. Ezzel szemben az Ön felelőssége, hogy gondoskodjon a használt készülékének megfelelő kezeléséről, azáltal, hogy átadja azt egy kijelölt gyűjtőhelyen az elektronikus és elektronikai készülék újrahasznosítására érdekében. A használt készülékek külön gyűjtése és újrahasznosítása természeti erőforrások megőrzését szolgálja, és egyben biztosítja, hogy olyan módon kerüljenek a készülékek újrahasznosításra, amely védi az emberi egészséget és a környezetet. Arra vonatkozó további információért, hogy hol adhatja le használt termékét annak érdekében, hogy az újrahasznosításra kerüljön, kérjük, keresse fel a helyi önkormányzatot, a háztartási hulladék eltávolítását végző szolgáltatót vagy az üzletet, amelyben a terméket vásárolta. Amennyiben további információra van szüksége a Monster termékekről, keresse fel honlapunkat: www.MonsterCable.com.

Cesky



Informace pro spotřebitele při uplatnění Směrnice Evropského parlamentu a Rady 2002/96/ES o odpadních elektrických a elektronických zařízeních

Tento výrobek podléhá předpisům Evropské Unie, které se vztahují na opětovné použití a recyklaci použitých elektrických a elektronických zařízení. K výrobě tohoto výrobku bylo nutné využít přírodních zdrojů. Tento výrobek může obsahovat nebezpečné látky. Výše uvedený symbol umístěný na výrobku nebo na jeho obalu znamená, že daný výrobek nesmí být odstraněn s ostatním odpadem pocházejícím z Vaší domácnosti. Je Vaší povinností toto elektrozařízení odevzdat na určené sbírné místo k recyklaci elektroodpadu. Oddělený sběr a recyklace elektroodpadu při jeho odstranění napomáhá zachování přírodních zdrojů a zajišťuje, aby recyklace probíhala způsobem, který chrání lidské zdraví a životní prostředí. Podrobné údaje o tom, kde elektroodpad můžete odevzdat k recyklaci, získáte na příslušném úřadu místní samosprávy, u společnosti zajišťující zpracování odpadu z domácnosti nebo v obchodě, kde jste daný výrobek zakoupili. Více informací o výrobcích Monster získáte na internetových stránkách: www.MonsterCable.com.

Slovensky



Informácie pre spotrebiteľa pri uplatnení Smernice Európskeho parlamentu a Rady 2002/96/ES o odpade z elektrických a elektronických zariadení

Tento výrobok podlieha predpisom Európskej únie, ktoré sa vzťahujú na opätovné použitie a recykláciu použitých elektrických a elektronických zariadení. K výrobe tohto výrobku bolo nutné využiť prírodných zdrojov. Tento výrobok môže obsahovať nebezpečné látky. Hore uvedený symbol umiestnený na výrobku alebo na jeho obale znamená, že daný výrobok nesmie byť zneškodnený spoločne s ostatným odpadom pochádzajúcim z Vašej domácnosti. Je Vašou povinnosťou toto elektrozariadenie odovzdať na určené zberné miesto k recyklácii elektroodpadu. Oddelený zber a recyklácia elektroodpadu pri jeho zneškodnení napomôže zachovaniu prírodných zdrojov a zabezpečí, aby recyklácia prebehla spôsobom, ktorý chráni ľudské zdravie a životné prostredie. Podrobné údaje o tom, kde elektroodpad môžete odovzdať k recyklácii, získate na príslušnom úrade miestnej samosprávy, u spoločnosti zabezpečujúcej spracovanie odpadu z domácností alebo v obchode, kde ste daný výrobok zakúpili. Viac informácií o výrobcích Monster získate na internetových stránkách: www.MonsterCable.com.



Verbraucherinformation in Anwendung der EU-Richtlinie über Elektro- und Elektronik-Altgeräte 96/2002

Dieses Produkt unterliegt Bestimmungen der Europäischen Union, die die Wiederverwendung und das Recycling von gebrauchten Elektro- und Elektronikgeräten fördern. Dieses Produkt erfordert die Gewinnung und Verwendung von natürlichen Ressourcen und enthält unter Umständen gefährliche Stoffe. Das oben abgebildete Symbol auf dem Produkt oder der Verpackung bedeutet, dass dieses Produkt nicht mit Ihrem anderen Haushaltsabfall entsorgt werden darf. Statt dessen sind Sie dafür verantwortlich, Ihr Altgerät zu entsorgen, indem Sie es an eine designierte Rücknahmestelle für das Recycling von Elektro- und Elektronik-Altgeräten übergeben. Die separate Sammlung und das Recycling Ihrer Altgeräte bei der Entsorgung wird dazu beitragen, natürliche Ressourcen zu erhalten und sicherzustellen, dass die Geräte in einer Weise recycelt werden, die die Gesundheit der Menschen und die Umwelt schützt. Für weitere Informationen darüber, wo Sie Ihre Altgeräte zum Recycling abgeben können, wenden Sie sich bitte an Ihre Gemeinde, Ihre Haushaltsabfallentsorgungsstelle oder das Geschäft, wo Sie das Produkt erworben haben. Für weitere Informationen über Monster-Produkte, besuchen Sie uns bitte auf www.MonsterCable.com.



Πληροφορίες στους καταναλωτές κατ' εφαρμογή της Οδηγίας 2002/96/ΕΚ σχετικά με τα απόβλητα ειδών ηλεκτρικού και ηλεκτρονικού εξοπλισμού (ΑΗΗΕ)

Αυτό το προϊόν υπόκειται στους κανόνες της Ευρωπαϊκής Ένωσης οι οποίοι προωθούν την αξιοποίηση και ανακύκλωση του μεταχειρισμένου ηλεκτρικού και ηλεκτρονικού εξοπλισμού. Για αυτό το προϊόν απαιτήθηκε η εξαγωγή και χρησιμοποίηση φυσικών πόρων και σε αυτό μπορεί να περιέχονται επικίνδυνα συστατικά. Το παραπάνω σύμβολο, επάνω στο προϊόν ή στη συσκευασία του, υποδεικνύει ότι αυτό το προϊόν δεν πρέπει να διατίθεται μαζί με τα υπόλοιπα οικιακά απόβλητα. Αντ' αυτού, αποτελεί δική σας ευθύνη η διάθεση των αποβλήτων ειδών ηλεκτρικού και ηλεκτρονικού εξοπλισμού σας, παραδίδοντάς τα σε ειδικό σημείο συλλογής για την ανακύκλωση των αποβλήτων ειδών ηλεκτρικού και ηλεκτρονικού εξοπλισμού. Η ξεχωριστή συλλογή και ανακύκλωση των αποβλήτων ειδών ηλεκτρικού και ηλεκτρονικού εξοπλισμού σας την ώρα της διάθεσης θα βοηθήσει τη διατήρηση των φυσικών πόρων και θα εξασφαλίσει την ανακύκλωσή τους με τέτοιο τρόπο ώστε να προστατευθεί η ανθρώπινη υγεία και το περιβάλλον. Για περισσότερες πληροφορίες σχετικά με το πού μπορείτε να παραδώσετε τα απόβλητα ειδών ηλεκτρικού και ηλεκτρονικού εξοπλισμού σας προς ανακύκλωση, παρακαλώ επικοινωνήστε με το αρμόδιο τοπικό γραφείο, την υπηρεσία διάθεσης οικιακών αποβλήτων ή το κατάστημα από το οποίο προμηθευτήκατε το προϊόν. Για περισσότερες πληροφορίες σχετικά με τα προϊόντα Monster, παρακαλώ επισκεφθείτε μας στην ηλεκτρονική διεύθυνση www.MonsterCable.com.



Informacija vartotojams apie ES Direktyvos 2002/96/EB dėl elektros ir elektroninės rangos atliekų (EE A) taikymą

Šiam gaminiui taikomi ES reikalavimai, skatinantys panaudotos elektros ir elektroninės rangos pakartotinį panaudojimą ir perdirbimą. Šio produkto gamybai yra panaudoti išgauti gamtiniai išteklių, taip pat jo sudėtyje gali būti pavojingų medžiagų. Aukščiau pateiktas simbolis ant paties gaminio arba ant jo pakuotės rodo, kad šio gaminio negalima išmesti kartu su kitomis buitinėmis atliekomis. Jis patys atsako už tai, kad jis elektros ir elektroninės rangos atliekos būtų perduotos perdirbimui tam skirtu surinkimo punktu. Atskiras jis išmetamos rangos atliekų surinkimas ir perdirbimas padės išsaugoti gamtinius išteklius ir užtikrins, kad jos bus perdirbamos žmonių sveikatai ir aplinkai saugiai būdu. Papildomos informacijos apie tai, kur galite palikti savo rangos atliekas perdirbimui, prašome teirautis savo miesto seniūnijoje, buitinių atliekų šalinimo tarnyboje, arba parduotuvėje, kurioje pirkote gaminį. Daugiau informacijos apie „Monster“ prekes ieškokite internete: www.MonsterCable.com.



Informasjon til forbrukere i henhold til EU-direktiv 96/2002

Dette produktet er underlagt virkeområdet for EU-regelverk som oppfordrer til gjenbruk og resirkulering av brukt elektrisk og elektronisk utstyr. Fremstilling av dette produktet har gjort det nødvendig å utvinne og bruke naturressurser som kan være skadelige. Det ovenstående symbolet, på produktet eller på pakningen, betyr at produktet ikke må kastes sammen med annet husholdningsavfall. I stedet er det ditt ansvar å innlevere brukt utstyr som skal kastes til et mottakssted for brukt elektrisk og elektronisk utstyr. Innsamling og resirkulering av ditt brukte elektriske og elektroniske utstyr som skal kastes vil bidra til vern av naturressursene og sikre at utstyret resirkuleres på en måte som hindrer helsekader og skader på miljøet. For mer informasjon om hvor du kan levere brukt utstyr for resirkulering, kan du kontakte din lokale kommune eller forhandleren der du kjøpte produktet. For mer informasjon om Monster-produktene, se www.MonsterCable.com.

MONSTER
MonsterCable.com

© 2006 Monster Cable Products, Inc.
455 Vally Drive • Brisbane, CA 94005, USA • 1-877-800-8989

Monster Cable International Ltd.
Ballymaley Business Park
Gort Road, Ennis, Co. Clare, Ireland • 001-866-348-4171

MONSTER CABLE®

USER GUIDE & WARRANTY



We invite you to visit the Monsters at MonsterCable.com

Engineered in the USA and manufactured for Monster quality specifications.

Made in China.

© 2007 Monster Cable Products, Inc.
455 Valley Drive, Brisbane, CA 94005
1-877-800-8989

Monster, Monster Cable, the MC logo, the Certified 1080p logo and the High Speed logo, the product and packaging are trademarks or registered trademarks of Monster Cable Products, Inc. or its subsidiaries in the U.S. and other countries. HDMI and High Definition Multimedia Interface are trademarks or registered trademarks of HDMI Licensing, LLC.

rm 164156

Advanced 3-Way Switcher for HDMI™

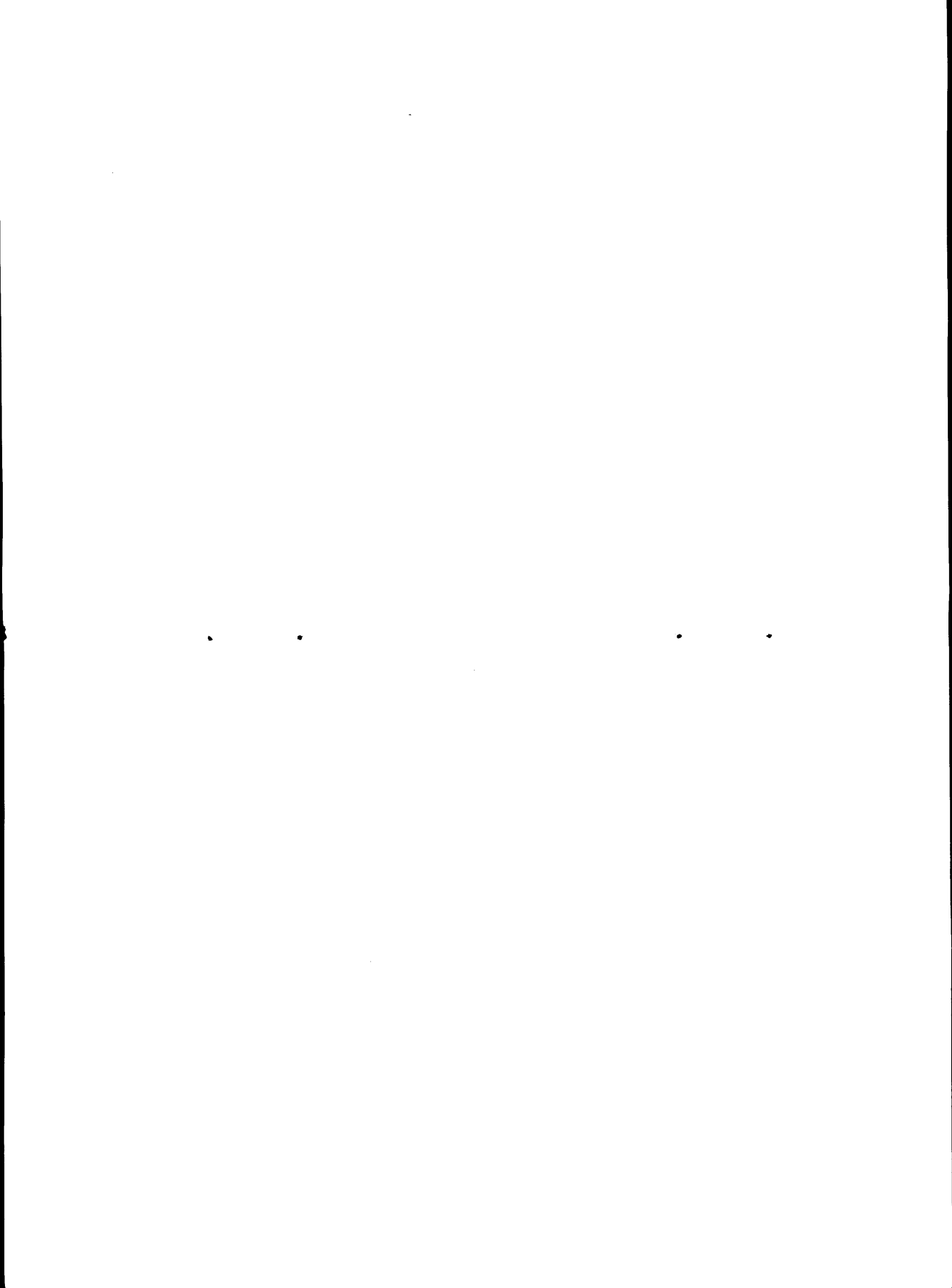

A NOTE FROM THE HEAD MONSTER

Dear Enthusiast,

THANK YOU for purchasing the Monster Cable® Advanced 3-Way Switcher for HDMI™. Our switcher allows you to instantly connect three additional 1080p high definition sources to your HDTV and control them with your existing universal remote. Finally, it's convenient and easy to hook up all of your components with the ultimate HD connection.



A stylized, handwritten signature in black ink, appearing to read 'Noel Lee'.

Noel Lee,
The Head Monster

More Great Monster Advanced™ for HDMI™ Products

Advanced 1080p Performance Maximizer

Experience the best picture and sound from your HDTV and high definition sources. Integrated jitter-reduction circuitry corrects digital signal timing errors for the sharpest picture and most accurate color.

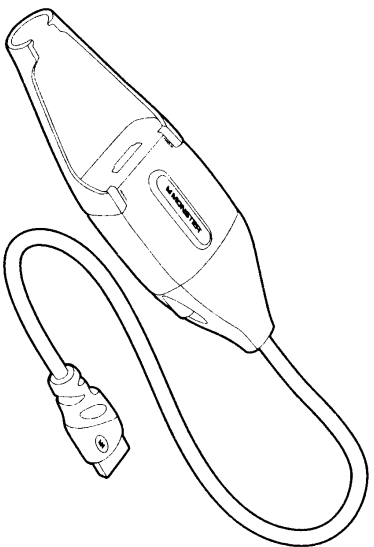

1000HD for HDMI Cable

Ultra-high speed digital video and audio cable for the sharpest picture, deepest color, and highest resolution sound.

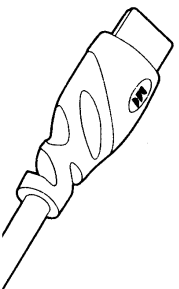

For more details on all of our Monster Cable products, visit us at MonsterCable.com

FORMAL WARRANTY CLAIM

How To Make A Claim. In the event damage has occurred to Products, You must follow these instructions: (1) Call Monster within two (2) months after You discover a Product Defect (or should have discovered it; if such Product Defect was obvious); (2) Give a detailed explanation of how the damage occurred; (3) Obtain a Return Authorization Number; (4) Upon receipt of a claim form (which may be sent to You after You filed Your Formal Warranty Claim), fill out the claim form entirely; (5) Return the Products, shipping prepaid by You (to be refunded if You are entitled to a remedy under the Scope of this Limited Warranty), to Monster for verification of damage, along with a copy of Your original sales receipts and proof of purchase (UPC label or packing slip) for such Products, the completed claim form, and printed Return Authorization Number on the outside of the return package (the claim form will include instructions for return).

Telephone Numbers. United States: 1 877 800-8989 or 415-840-2000, Canada 1-866-348-4171, Czech Republic 800-14247, UK 0800 0569520, Germany 0800 1819388, France 0800 918201, Netherlands 0800 0228919, Belgium 0800 79201, Norway 800 10906, Denmark 8088 2128, Sweden 020 792650, Finland 800 112768, Greece 00800 35312008, Russia 810 80020051353, Italy 800 871479, Spain 900 982909.

Further Proceedings. Monster will determine whether a Product Defect existed. Monster may, at its discretion, direct You to obtain a repair estimate at a service center. If a repair estimate is required, You will be instructed on how to properly submit the estimate and the resulting invoice to Monster for payment. Any fees for repairs may be negotiated by Monster.

Timing. If You bring a Formal Warranty Claim and fully comply with all terms and conditions of this Limited Warranty, Monster will use its best efforts to provide You with a remedy within thirty (30) days after receipt of Your Formal Warranty Claim (if You reside in the United States - forty-five (45) days if You reside elsewhere), unless obstacles outside Monster's control delay the process.

Ver:062706 - US

©2003-2007 Monster Cable Products, Inc.

transferred ownership of the Product, whichever occurs earlier. Also, You must call Monster and obtain a Return Authorization Number (as described under "How to Make a Claim") within two (2) months after You discover a Product Defect (or should have discovered it, if such Product Defect was obvious).

"You" means the first individual person that purchased the Product in its original packaging from an Authorized Dealer. This Limited Warranty does not apply to persons or entities that bought the Product (i) in used or unpackaged form, (ii) for resale, lease or other commercial use, or (iii) from someone other than an Authorized Dealer.

SCOPE OF THIS LIMITED WARRANTY

Products. If a Product contained a Product Defect when You bought it from an Authorized Dealer and Monster receives a Formal Warranty Claim from You within two (2) months after You discover such Product Defect (or should have discovered it, if such Product Defect was obvious) and before the end of the Warranty Period for Product Defects applicable to the affected Product, then Monster will provide You with one of the following remedies: Monster will (1) repair or, at Monster's sole discretion, replace the Product, or (2) refund to You the purchase price You paid to the Authorized Dealer for the affected Product if repair or replacement is not commercially practicable or cannot be timely made. **NOTE: MONSTER DOES NOT ASSUME ANY LIABILITY FOR ANY INCIDENTAL, CONSEQUENTIAL OR INDIRECT DAMAGES UNDER THIS LIMITED WARRANTY.**

GENERAL PROVISIONS

Choice Of Law/Jurisdiction. This Limited Warranty and any disputes arising out of or in connection with this Limited Warranty ("Disputes") shall be governed by the laws of the State of California, USA, excluding conflicts of law principles and excluding the Convention for the International Sale of Goods. The courts located in the State of California, USA shall have exclusive jurisdiction over any Disputes.

Other Rights. THIS LIMITED WARRANTY GIVES YOU SPECIFIC LEGAL RIGHTS, AND YOU MAY ALSO HAVE OTHER RIGHTS, WHICH VARY FROM STATE TO STATE AND JURISDICTION TO JURISDICTION, AND WHICH SHALL NOT BE AFFECTED BY THIS LIMITED WARRANTY. THIS WARRANTY EXTENDS ONLY TO YOU AND CANNOT BE TRANSFERRED OR ASSIGNED. If any provision of this Limited Warranty is unlawful, void or unenforceable, that provision shall be deemed severable and shall not affect any remaining provisions. In case of any inconsistency between the English and other versions of this Limited Warranty, the English version shall prevail.

Registration. Please register Your Product at www.MonsterCable.com/Warranty. Failure to register will not diminish Your warranty rights.

Product Model	Warranty Period for Product
HDMI Switcher	One (1) Year

Package Contents

Advanced 3-Way Switcher for HDMI (1)

External Low-Noise Power Supply (1)

Mountable External Infrared Receiver (1)

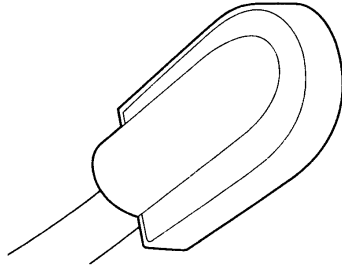

Mountable External Infrared Receiver

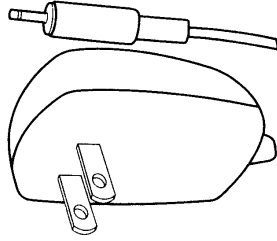

External Low-Noise Power Supply

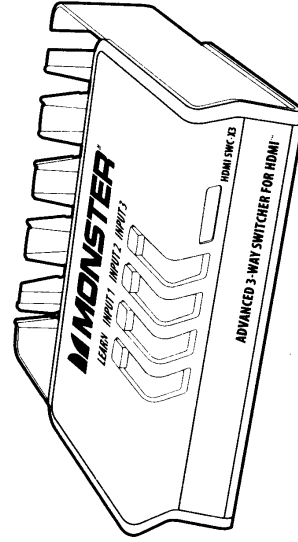

3-Way (3-In 1-Out) Advanced Switcher for HDMI

Specifications:

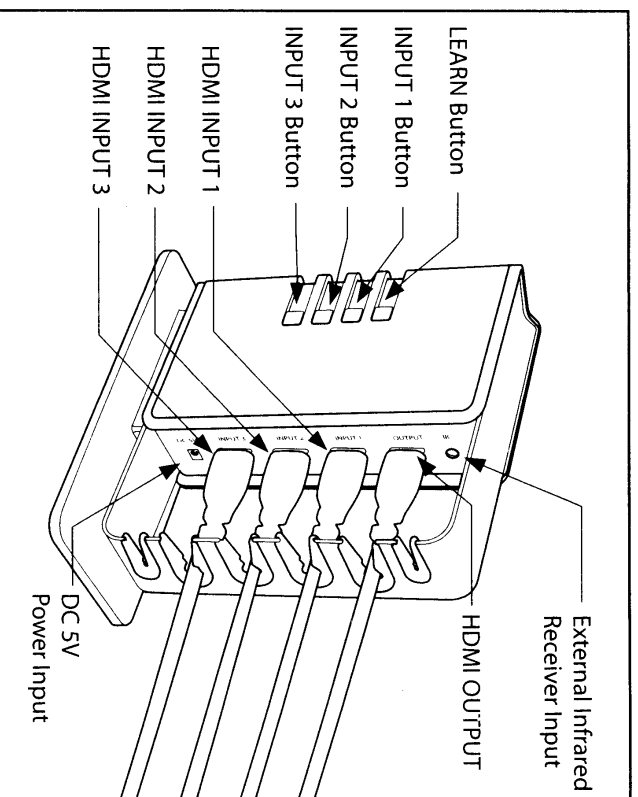

- Signal Output.....4.95 Gbps
- Power Consumption (Max.)..... 1.0 W
- Power Supply 100~240V AC (50/60 Hz), 5V DC/0.5A
- Video Resolution Up to 1080p
- HDMI Input/Output Connector Type A
- Dimensions (H x W x D) 179x80x177mm with stand
- Weight without Power Supply 1.2 lbs (542 g)

LIMITED WARRANTY FOR CONSUMERS

Monster Cable Products, Inc., 455 Valley Drive, Brisbane, CA 94005, USA, (415) 840-2000 ("Monster") extends You this Limited Warranty. Statutory or common law may provide You with additional rights or remedies, which shall not be affected by this Limited Warranty.

DEFINITIONS

"Adequate Use" means use of the Product (i) within a home or dwelling, (ii) for private (as opposed to commercial) purposes, (iii) in conformance with all applicable local, state or federal law, code or regulations (including without limitation building and/or electrical codes), (iv) in accordance with manufacturer recommendations and/or instructions in the materials and documentation that accompany the Product, and (v) if applicable, with proper electrical grounding.

"Authorized Dealer" means any distributor, reseller or retailer that (i) was duly authorized to do business in the jurisdiction where it sold the Product to You, (ii) was permitted to sell You the Product under the laws of the jurisdiction where You bought the Product, and (iii) sold You the Product new and in its original packaging.

"Formal Warranty Claim" means a claim made in accordance with the section "Formal Warranty Claims" herein.

"Product" means a Product (i) that is listed in the Specifications Table below, (ii) that You bought from an Authorized Dealer new and in its original packaging, and (iii) whose serial number, if any, has not been removed, altered, or defaced.

"Product Defect" means an inadequacy of the Product that existed at the time when You received the Product from an Authorized Dealer and that causes a failure of the Product to perform in accordance with Monster's documentation accompanying the Product, unless such failure has been caused completely or partly by (a) any use other than Adequate Use, (b) transportation, neglect, misuse or abuse by anyone other than Monster's employees; (c) alteration, tampering or modification of the product by anyone other than a Monster employee; (d) accident (other than a malfunction that would otherwise qualify as a Product Defect); (e) maintenance or service of the Product by anyone other than a Monster employee; (f) exposure of the Product to heat, bright light, sun, liquids, sand or other contaminants; or (g) acts outside the control of Monster, including without limitation acts of God, fire, storms, earthquake or flood.

"Warranty Period" means the time period during which Monster must have received Your Formal Warranty Claim. The different Warranty Periods related to Product Defects are defined in the Specifications Table below. The Warranty Period commences on the date when You purchased or received (whichever occurs later) the Product from an Authorized Dealer as evidenced by the Authorized Dealer's invoice, sales receipt or packing slip. If You do not have written proof of the date of purchase or receipt, then the Warranty Period commences three (3) months after the date when the Product left Monster's or its factory as evidenced by Monster's records. The Warranty Period ends after the time defined in the Specifications Table has expired or after You have

IMPORTANT RF EMISSIONS INFORMATION

This equipment has been tested and found to comply with the limits for a Class B digital device, pursuant to part 15 of the FCC Rules. These limits are designed to provide reasonable protection against harmful interference in a residential installation. This equipment generates, uses and can radiate radio frequency energy and, if not installed and used in accordance with the instructions, may cause harmful interference to radio communications. However, there is no guarantee that interference will not occur in a particular installation. If this equipment does cause harmful interference to radio or television reception, which can be determined by turning the equipment off and on, the user is encouraged to try to correct the interference by one or more of the following measures:

- Reorient or relocate the unit.
- Increase the distance between the unit and connected equipment.
- Connect the unit to an outlet on a different circuit from the display.

Consult your local dealer or an experienced radio/TV technician for help. If you cannot eliminate the interference, the FCC requires that you stop using your product. Changes or modifications not expressly approved by Monster may cause interference and void the user's authority to operate the equipment. This device complies with Part 15 of the FCC Rules. Operation is subject to the following two conditions:

1. this device may not cause harmful interference, and
2. this device must accept any interference received, including interference that may cause undesired operation.

Product	3-Way Advanced HDMI Switcher
Model	HDMI SWC-X3
Responsible Party	MONSTER CABLE 455 Valley Drive, Brisbane, CA 94005
Phone	1-877-800-8989

Connecting the Advanced 3-Way Switcher

- 1) Orient the switcher vertically or horizontally, based on your available space.

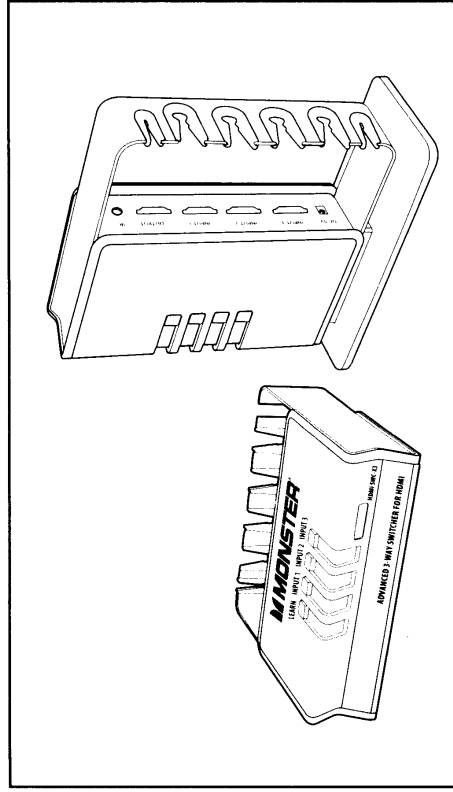

- 2) Insert the power supply's DC adapter into the switcher's DC 5V input. Next, insert the power supply's two-prong plug into a standard AC outlet. The INPUT 1 LED should illuminate.

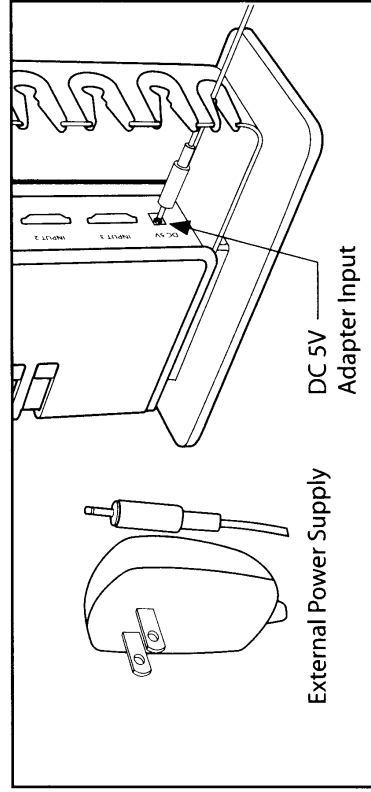

3) Using Monster Advanced for HDMI Cables, connect up to three HDMI devices (DVD player, cable/satellite receiver, PLAYSTATION® 3) to the HDMI inputs on the switcher.

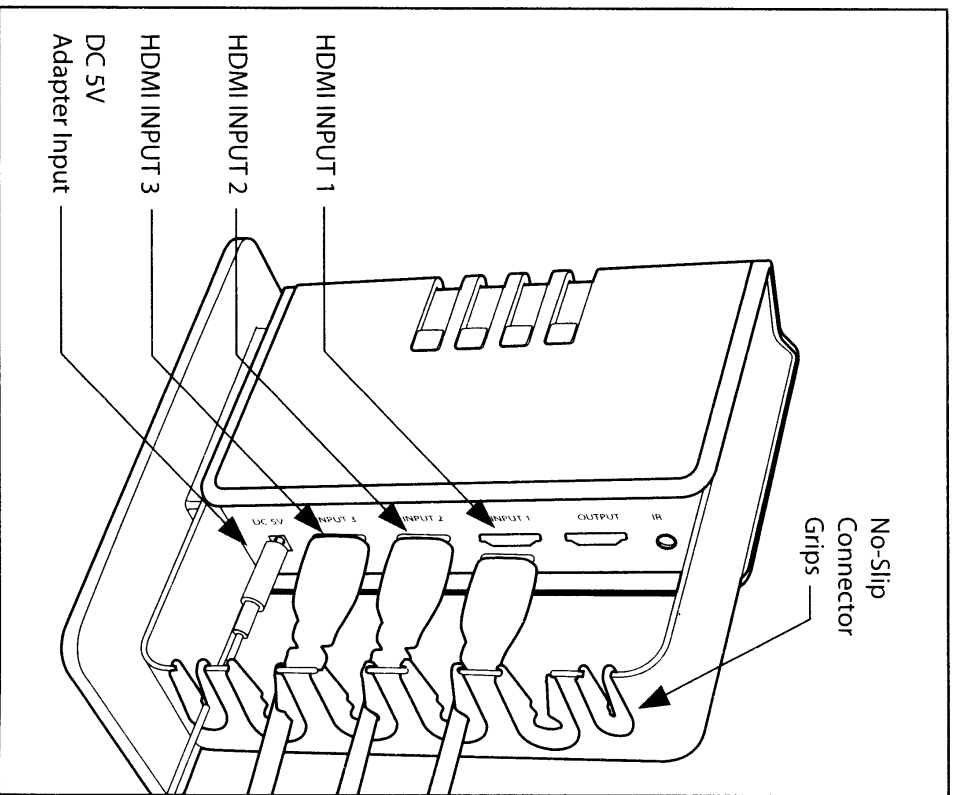

4

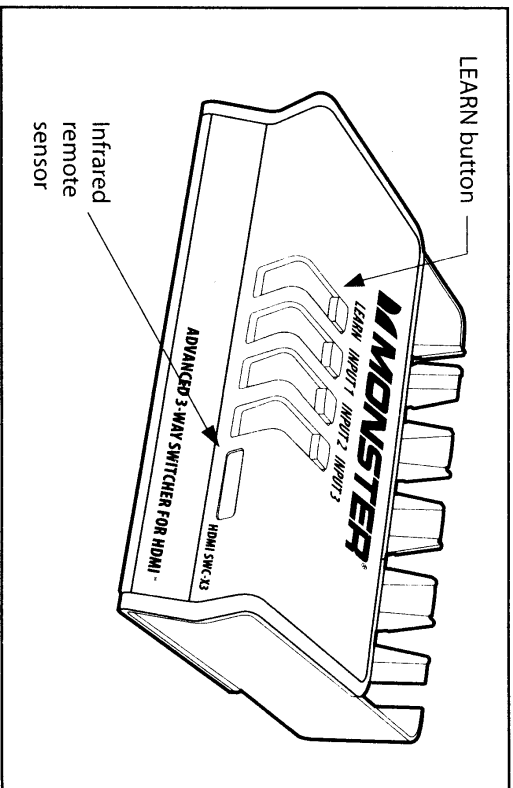

Congratulations, you've successfully installed your Advanced 3-Way Switcher.

Visit us at MonsterCable.com/HDMI to find more great Monster Advanced for HDMI products that deliver the best in high definition home theater.

9

- 1) Press the LEARN button. The LEARN indicator will illuminate.
- 2) When the LEARN indicator lights up, press the INPUT 1 button. The INPUT 1 indicator will illuminate.
- 3) Point your remote control (not supplied) at the switcher's internal sensor, or the mounted external receiver, and press the button on your remote that matches the component connected to INPUT 1. For example, press "DVD," if your DVD player is connected to INPUT 1. This will allow you to use the "DVD" button to select that input on each of your components (DVD player, AV receiver, TV, etc.).
- 4) Repeat steps 2 through 3 for your other connected components.
- 5) To switch between components, press the designated buttons on your remote.

- 4) Connect another Monster Cable for HDMI to the switcher's output. Attach this cable to an HDMI input on your HDTV or monitor.

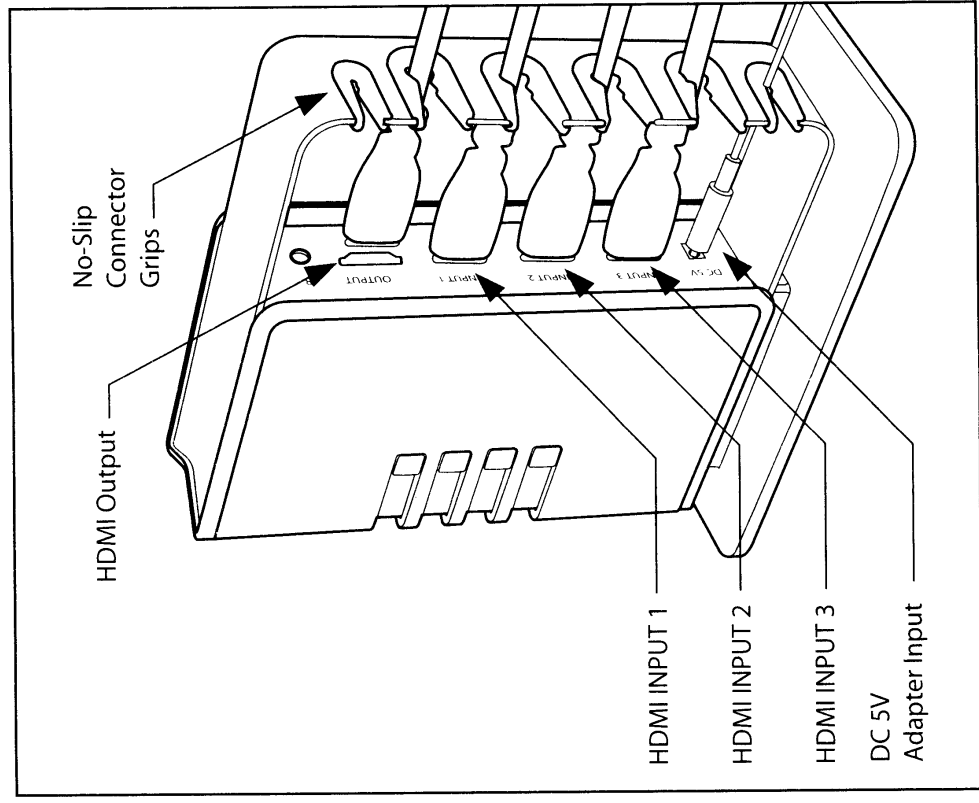

Attaching the Mountable External Infrared Receiver

The Advanced 3-Way Switcher features an external IR receiver, allowing you to hide it from view, but still maintain full remote control.

- 1) Place the switcher in the desired location. Select a location with convenient access to an AC outlet.
- 2) Using the adhesive strip on the bottom of the external receiver, mount the receiver to a flat surface within line of sight of your seating/viewing area.
- 3) Route the external receiver's cable to the switcher. Connect the cables 1/8" mini-jack connector to the mini-jack input on the back of the switcher, labeled "IR".

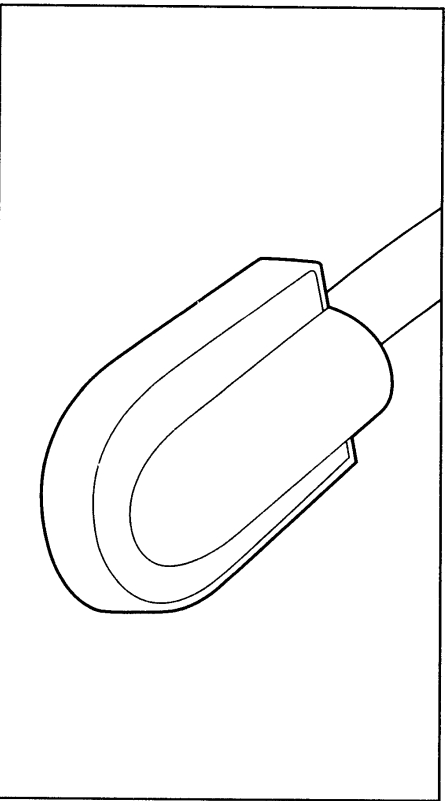

6

Switching HDMI Components Manually

Press the INPUT 1, INPUT 2, or INPUT 3 button on the switcher to select that input's connected component.

Switching HDMI Components with a Universal Remote Control

The switcher has a "learn" mode, which allows the unit to automatically learn your remote control. The switcher can learn to be controlled by virtually any universal remote. To activate the learning mode, follow the instructions on the next page.

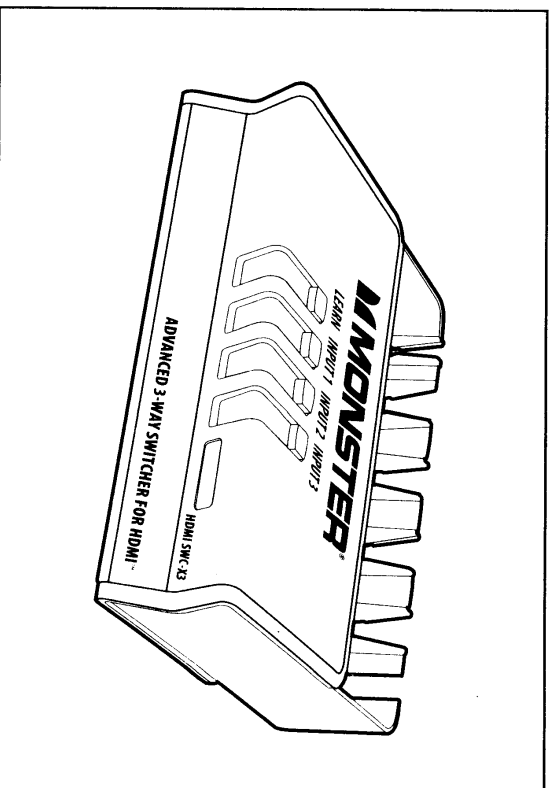

7