

MONSTER POWER[®]

The logo features the words "MONSTER" and "POWER" in a bold, metallic, 3D-style font. A vibrant, multi-colored swoosh (rainbow gradient) curves around the right side of the text, starting from the top of "MONSTER" and ending at the bottom of "POWER".

Home Theatre
Reference PowerCenter[™]
HTS 3600

Owner's Manual

TABLE OF CONTENTS

	Page
Important Safety Precautions	i
Proper Grounding and Installation Tipsiv
Introduction1
Monster’s Patented Clean Power Stages2
The Design Minds of Monster Power.3
Content Check List5
Hookup Guide6
Product Features16
Troubleshooting21
Frequently Asked Questions26
Appendices	
A. Glossary of Terms28
B. Warranty Information31
C. How to Contact Us35
D. Warranty Registration36

IMPORTANT SAFETY PRECAUTIONS

Please read and observe the following safety points at all times.

WARNING – Power Sources

Do not plug this Monster PowerCenter into a power outlet that differs from the source indicated for safe use on the Monster PowerCenter. If you don't know the type of electrical power that is supplied to your home, please consult your local power company.

WARNING – Grounding and Polarization

A. Your Monster PowerCenter has a three-wire grounding-type AC plug (a three-prong plug).

This plug is designed to be inserted into a grounding-type outlet only. If this plug doesn't fit directly inside your outlet, do not attempt to force it into the outlet. Instead, reverse the plug and reinsert it. If this doesn't work, contact a local electrician to install the proper polarized outlet. Never attempt to dismantle the plug in any way (or to alter an extension cord) to make it fit into a two-prong outlet. Do not attempt to defeat the grounding feature by using a 3-to-2 prong adapter. Instead, call a local electrician to install a properly grounded outlet.

B. If you use rooftop devices such as satellite dishes, antennas, or any other component with wire that connects to your PowerCenter, be sure the wire(s) is properly grounded. Use grounding techniques specified in section 810 of the National Electrical Code (NEC), AAS/NFPA 70 (in Canada, part 1 of the Canadian Electrical Code). This protects against voltage surges and static charges. Do not place any antenna component near overhead power lines, or any other power circuit. Do not touch any power line or power circuit. Doing so may cause you severe physical injury and possibly death.

⚠ WARNING – Proper Cleaning

In general, the only cleaning necessary for your Monster PowerCenter is a light dusting.

Unplug your component from the wall before cleaning it. Do not use any type of liquid or aerosol cleaners. Lightly moisten a cloth with water to clean the outside of your Monster PowerCenter.

⚠ WARNING – Liquid: Avoiding Electrical Shocks

Do not operate your Monster PowerCenter if liquid of any kind is spilled onto or inside the unit.

Do not operate your Monster PowerCenter near rain or water that's spilled or contained (e.g., bathtub, kitchen or bathroom sink).

⚠ WARNING – Power Cord Safety

A. When routing your Monster PowerCenter AC power cord, do not place it near heavy foot traffic areas (e.g., hallways, doorways, and kitchen floors). Do not create a trip hazard with the power cord.

B. If your power cord's protective jacket begins to rip or fray, exposing the internal wiring, shielding, etc., disconnect it from the power source and discontinue use of the Monster PowerCenter immediately. See the warranty section of this owner's manual. (page 32)

⚠ CAUTION – Exposure To Heat

Do not expose your Monster PowerCenter to direct sunlight or place it near wall heaters, space heaters, or any enclosed space prone to temperature increase (e.g., car trunk).

⚠ WARNING – Storm Precautions

In the event of a lightning storm, immediately disconnect your Monster PowerCenter from its power source.

After you've done this, it's not necessary to disconnect any components from your Monster PowerCenter.

⚠ WARNING – No User Serviceable Parts Inside

If, for any reason, your Monster PowerCenter is not operating properly, do not remove any part of the unit (cover, etc.) for repair. Unplug the unit and consult this owner's manual for warranty and service information.

PROPER GROUNDING AND INSTALLATION TIPS

CAUTION – Proper Grounding

Monster PowerCenters require a properly grounded 3-wire outlet to protect connected equipment. If your AC outlet is improperly wired (no ground or reverse polarity), the Green "Ground OK" light on the front panel of the Home Theatre Reference PowerCenter™ HTS 3600 will not light up. In this event, call an electrician to fix the problem in your home's wiring.

Many older buildings are inadequately wired. It's very common for a building to be improperly grounded. Building wiring and grounding must conform to applicable NEC (USA) or CEC (Canada) codes for the \$500,000 Limited Connected Equipment warranty to be valid. If you're not sure about your home's wiring, have it checked by a qualified electrician.

Note to CATV Installer:

This reminder is provided to call the CATV System Installer's attention to Article 820-40 of the NEC that provides specific guidelines for proper grounding and in particular, specifies that the cable ground shall be connected to the point of cable entry as practical.

IMPORTANT NOTE – Proper Power and Protection

To completely deliver clean power and protect your equipment against electrical surges, every wire into or out of your equipment must be connected to an appropriate Monster PowerCenter.

IMPORTANT NOTE – Proper Protection and the Limited Connected Equipment Warranty

The \$500,000 Limited Connected Equipment warranty becomes invalid if any wire (phone, coax, or AC), or audio or video interconnect leading into the equipment comes from a component that is not properly protected by the Monster PowerCenter.

NOTES

INTRODUCTION

Thank You

Thank you for purchasing Monster Power's Home Theatre Reference PowerCenter™ HTS 3600. The PowerCenter reflects Monster's commitment to creating performance-enhancing solutions for home theatre systems, so you will enjoy superior picture and sound quality.

Ordinary AC power accessories compromise the quality of the components they power. The PowerCenter's advanced technology and innovative design solves this problem and offers several unique convenience and performance features.

While your PowerCenter does an excellent job of protecting your components from harmful power surges, its main benefit is much more than just surge protection. Our exclusive Clean Power™ v.2.0 filter circuitry virtually stops the noise that goes right through typical surge protectors. There is more than one type of noise that can degrade connected equipment, however. Your PowerCenter also features revolutionary separate noise isolation between digital, audio, and video filtered outlets. If any noise from electronic products plugged into an outlet gets through our Clean Power noise filters and to the power line, it will have to go through another filter to get to an adjacent set of outlets. The result is high quality picture and sound that's free from performance-damaging interference.

Another Monster Power breakthrough is the PowerCenter's ultra-low loss RF circuitry. While other "line conditioners" feature coaxial outlets for convenience, their insertion loss can be up to 30dB. The PowerCenter's incredibly small insertion loss makes it ideal for all digital coaxial connections like DBS.® Your PowerCenter also features an exclusive color-coding system which identifies which component should be plugged in where and outlet filter type (digital, ultra-high current audio, analog audio, and video). This way, you won't jeopardize performance by plugging a high current component into a low current outlet or mistakenly plug a VCR into a switched outlet and be forced to reset its clock when power is interrupted.

As fellow audiophiles and videophiles, we designed your PowerCenter for the best possible picture and sound. Enjoy!

MONSTER'S PATENTED CLEAN POWER STAGES

Each PowerCenter features a stage of Clean Power. Clean Power performs two tasks vital to high performance audio, video and digital reproduction: filtration and isolation. The higher the Clean Power stage, the more sophisticated and advanced the filters are, to reject noise generated on the AC powerline. Also, the higher the Clean Power stage, the more isolation between connected equipment for maximum component-generated noise rejection. HTS 3600 features Clean Power v.2.0 Stage 3 for the best possible performance.

Clean Power Stage 3: Four ultra-advanced isolated filters including a digital filter for separate digital sources, analog audio, video, and ultra-high current audio filters provide the best possible AC powerline noise rejection and isolation of audio equipment from video equipment for improved component-generated noise rejection. Ideal for audiophile and videophile a/v systems and reference home theatres.

THE DESIGN MINDS BEHIND THE POWERCENTER



Richard Marsh – There are few experts able to solve the complex problems of AC power. Richard Marsh is one of the illustrious few. He has designed best selling power conditioning components costing more than \$3,000 and now brings his expertise to Monster Power. Richard developed Monster's exclusive Clean Power™ circuitry. He is also responsible for several other groundbreaking designs. Richard's background and research into amplifier and capacitor design led to his development of the Servo-DC feedback concept in power amplifiers – a concept that is used by virtually every amplifier manufacturer today. His status as both the inventor of the MultiCap™ internal bypass capacitor and as the driving force behind the high-end audio balanced circuit design concept has influenced the audiophile community for years. Richard is responsible for some of the high end audio world's most respected product designs, essays and articles as Technical Editor and contributed to *The Absolute Sound* and *Audio* magazine. He is included in *Who's Who in the West*.



Demian Martin – Demian Martin has been solving complex AC power problems for several years. As a technical consultant for successful paper and steel mills, Demian helped create several innovative AC power solutions. He developed techniques to dramatically improve the efficiency of these factories' high power motor control systems — up to 50,000 watts each. As a result, they avoided the costly premiums many factories must pay for AC power inefficiency. He now brings his expertise to Monster Power's elite research and development team.

Noel Lee – Noel Lee is best known for popularizing the concept of high performance audio cable 20 years ago with his creation of Monster Cable. Originally a laser-fusion design engineer at Lawrence Livermore National Laboratory and later a touring musician, Noel today has invented or co-invented over 125 U.S. and international patents and drives the explosive growth of The Monster Group into more than 80 countries worldwide. Monster Power is his realization of a long-nurtured vision of making affordable power accessories that deliver the best possible sound and picture.



CONTENT CHECKLIST

Before You Begin

Before you do anything, make sure you have everything you need to enjoy the high performance of your Monster PowerCenter. You'll need the following items to get started:

- 1) This owner's manual.
- 2) Your favorite pen or a computer with internet browser (for registering your warranty information).
- 3) One Monster Power Home Theatre Reference PowerCenter HTS 3600.
- 4) One sheet of Monster Power Audio/Video ID labels.
- 5) One Pair of rack ears.
- 6) One Monster Video cable.
- 7) One Monster Internet Phone cable.

HOOKUP GUIDE

STEP 1 Pay-Per-View/Phone Line Hookup

Please note that HTS 3600 is not intended for hookup of any phone which carries two separate phone lines on a single 4-pin jack.

- A) Connect the end of your phone cable into the phone wall outlet. Plug the other end into the HTS 3600 "Phone In" jack.
- B) Connect a second phone cable into one of the HTS 3600 "Phone Out" jacks and into the Pay-per-View input on your DBS receiver or DVD player.

FOR STANDARD TELEPHONE LINE PROTECTION (NOT A PAY-PER-VIEW COMPONENT)

- C) Connect a phone cable from the telephone wall jack to the HTS 3600 "Phone In" jack. Connect a second phone cable from one of the HTS 3600 "Phone Out" jacks to the telephone.

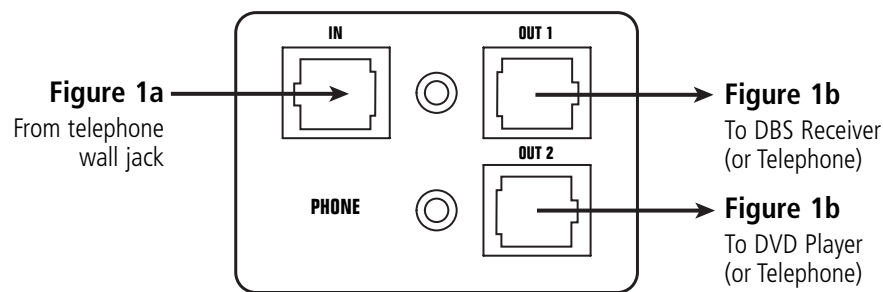

Figure 1

REMOTE AC CONTROL HOOKUP

STEP 2 Remote AC Control Hookup

This feature allows you to turn your PowerCenter On via the remote control that operates your A/V receiver or preamp.

- A) Plug in the Remote AC control cord's female end into back of your HTS 3600.
- B) Plug in the Remote AC control cord's 2-prong male end into the A/V receiver's Switched AC power outlet. When you turn on your Receiver or Preamp, the PowerCenter's Switched outlets will become active.

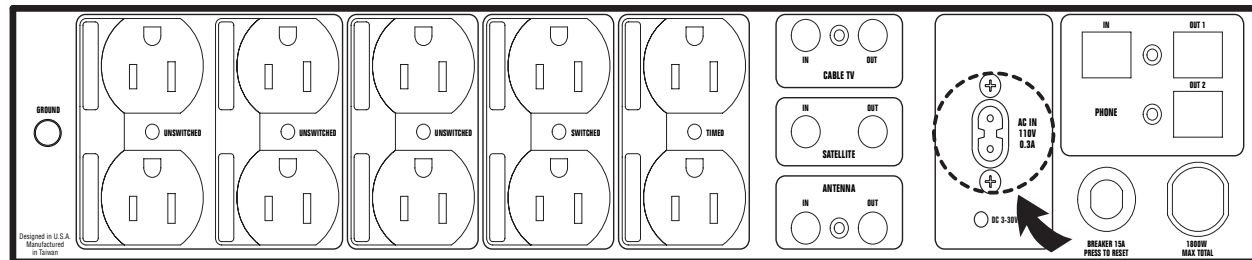

REMOTE DC CONTROL HOOKUP

STEP 3 Remote DC Control Hookup

This feature allows you to connect your PowerCenter to your Home Automated Control System conveniently. So, a component you don't want powered constantly (like your projector or surround amplifiers) can be plugged into one of your PowerCenter's "Switched" outlets and be remotely activated when needed. This feature also allows you to use any length of low voltage wire (not supplied) to remotely control multiple PowerCenters.

- A) Plug in a Remote DC control cable with an 1/8" miniplug (not supplied) to the corresponding outlet on the PowerCenter.
- B) Plug in the other end of the Remote DC control cord to the corresponding outlet on your custom installation component.

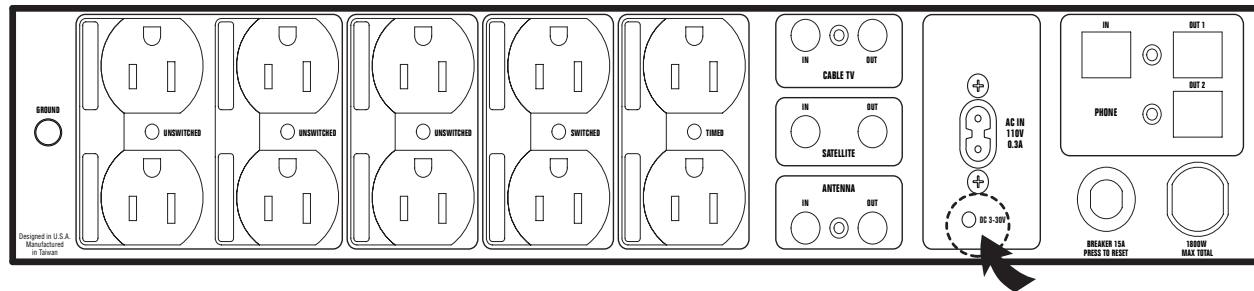

STEP 4 Coaxial input/output hookup

You will need additional coaxial cables to connect the HTS 3600 to your components. See illustration on page 15 which shows a proper grounding schematic.

Protect Cable TV, Satellite and Antenna Connections as Follows:

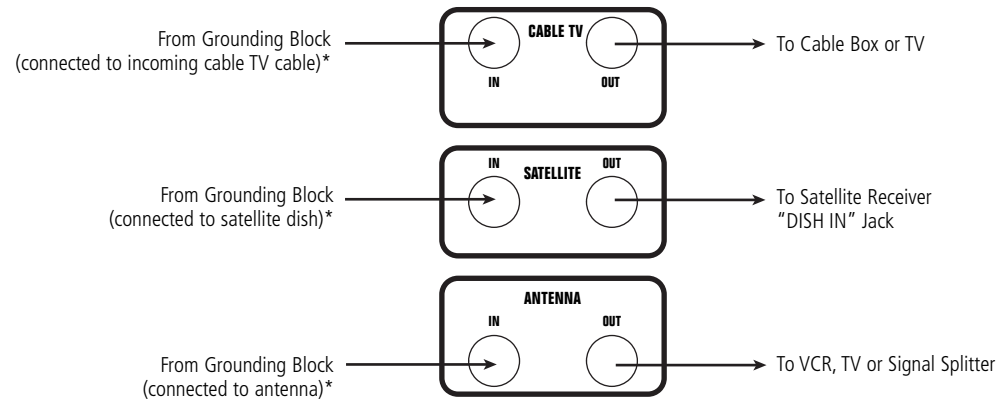

*See note on page vii regarding proper grounding.

STEP 5 Ultra-High Current Audio Outlet (Switched/Timed) Hookup

NOTE:

These outlets are designed to deliver maximum current to power hungry components like amplifiers and preamplifiers. Because certain components don't need continuous power, or shouldn't be turned on continuously, these outlets are "switched." This means the components plugged into these outlets won't receive power or shut down unless your PowerCenter is turned on or off. These outlets are also "timed," enabling sequential power activation of switched components. This way, high current amplifiers are turned on last and turned off first, preventing the "thump" from getting to your speakers.

- A) Attach a Monster Power® ID label to each component's power cord before you plug it into the appropriate color-coded PowerCenter outlet.
- B) **MAIN AMP:** Plug the power cord of any separate amplifier (not integrated receiver) into the HTS 3600's corresponding MAIN AMP outlet.
- C) **SPARE:** Plug your dedicated Spare power cord into the corresponding SPARE outlet.

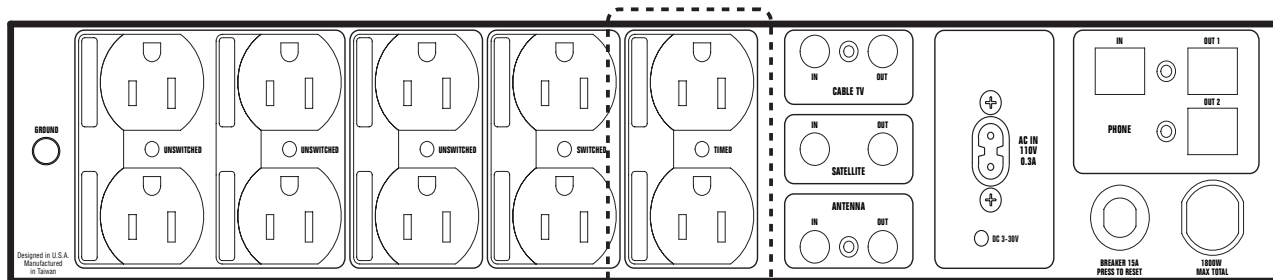

STEP 6 Analog Audio Filter Outlet (Switched) Hookup

NOTE

Because certain components don't need continuous power, or shouldn't be turned on continuously, these outlets are "switched." This means the components plugged into these outlets won't receive power or shut down unless your PowerCenter is turned on or off. You can plug any type of low current audio component (e.g., portable cassette player) or video component (e.g., camcorder) into the preamp or tape outlets.

- A) Attach a Monster Power® ID label to each component's power cord before you plug it into the appropriate color-coded PowerCenter outlet.
- B) **PREAMP/PROCESSOR:** Plug the preamp's power cord into the HTS 3600's corresponding PREAMP/PROCESSOR outlet.
- C) **A/V RECEIVER:** Plug your AV receiver's power cord into the corresponding RECEIVER outlet.

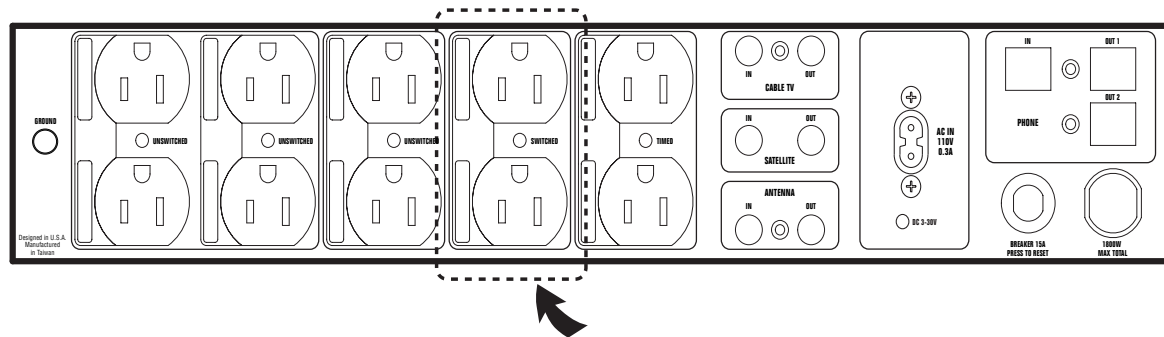

STEP 7 Video Filter Outlet (Unswitched) Hookup

NOTE

These outlets are "unswitched" because some components perform best when powered continuously. A VCR, for example, should be plugged into one of these outlets to avoid the hassle of resetting its clock when power is interrupted. Whether you turn your PowerCenter on or off, any component plugged into these outlets will receive continuous power as long as your PowerCenter is plugged into a properly grounded 120 volt wall socket. You can plug any type of analog video component (e.g., VCR, camcorder) into this outlet. Plug your component's power cord into the corresponding VCR or TV/MONITOR outlet.

- A) Attach a Monster Power® ID label to each component's power cord before you plug it into the appropriate color-coded PowerCenter outlet.
- B) **VCR:** Plug the VCR's power cord into the HTS 3600's corresponding VCR outlet.
- C) **TV/MONITOR:** Plug your TV's power cord into the corresponding TV/MONITOR outlet.

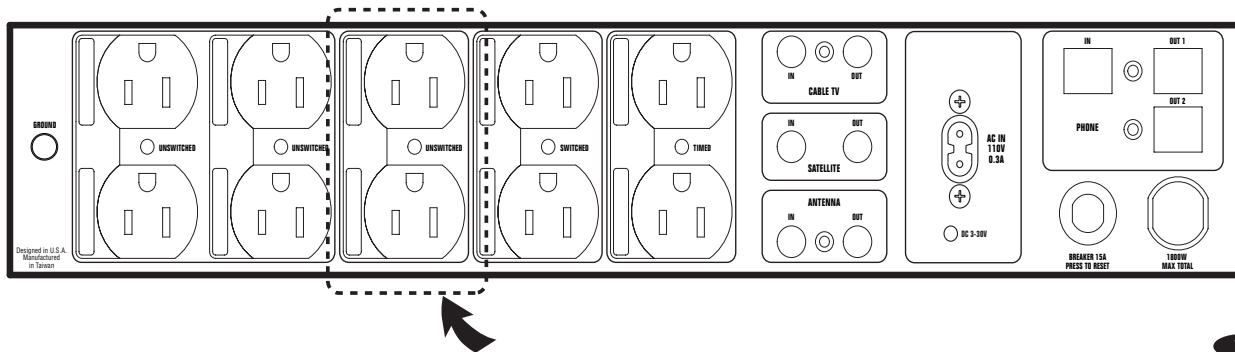

STEP 8 Digital Outlet (Unswitched) Hookup

NOTE

You can plug any type of digital component (e.g., CD player, DVD player, MiniDisc, Camcorder) into this outlet. Plug your component's power cord into the corresponding CABLE/SAT, CD, HDTV, OR DVD outlet.

- A) Attach a Monster Power® ID label to each component's power cord before you plug it into the appropriate color-coded PowerCenter outlet.
- B) **CABLE/SAT:** If you have a Cable TV box, plug its power cord into the HTS 3600's corresponding CABLE/SAT outlet. If you are using a Satellite Receiver, plug its power cord into the corresponding CABLE/SAT outlet.
- C) **CD:** Plug your CD player's power cord into the corresponding CD outlet.
- D) **HDTV:** Plug the power cord of your HDTV into the corresponding HDTV outlet.
- E) **DVD:** If you have a DVD player, plug its power cord into the corresponding DVD outlet. If you are using a LaserDisc player, plug its power cord into the corresponding DVD outlet. If you have both a LaserDisc player and DVD player, you can plug either component into any available "Unswitched" PowerCenter outlet.

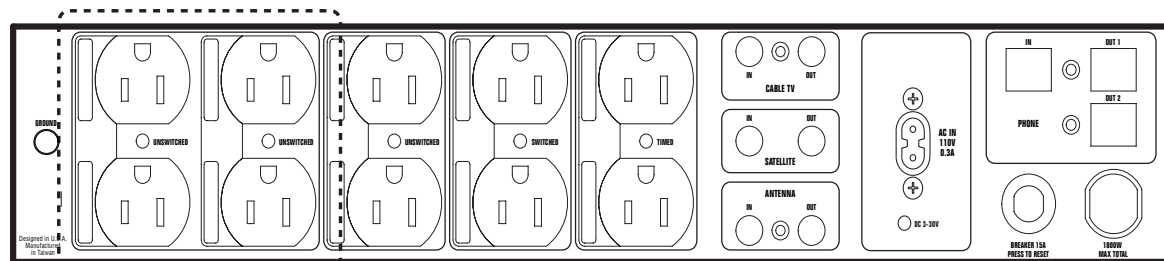

STEP 9 Rackmounting Your PowerCenter

- A) Remove your PowerCenter trim covers using a 3/32 Allen key (not included). Turn each Allen screw counter-clockwise until the screw is completely removed.
- B) Align one rack ear over the two 3/32 holes on the left side of the PowerCenter, lining up the rack's corresponding holes. Using a 3/32 Allen key, turn the two Allen screws (provided) clockwise until tight.
- C) Align the remaining two holes on the left side of the PowerCenter with the two holes on the left side of your rack. Using a Phillips screwdriver, turn the two Phillips screws (provided) clockwise until tight.
- D) Repeat Steps B and C for installation of the rack ear on the right side of PowerCenter.

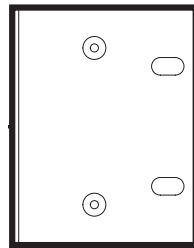

HTS 3600 Rack "Ear"

GROUNDING YOUR CABLE TV, SATELLITE DISH AND ANTENNA CONNECTIONS

IMPORTANT NOTE

Proper grounding can be accomplished by using a special grounding block attached to a cold water pipe or copper ground rod driven into the ground. Consult with an electrician to verify your outdoor connections are grounded properly.

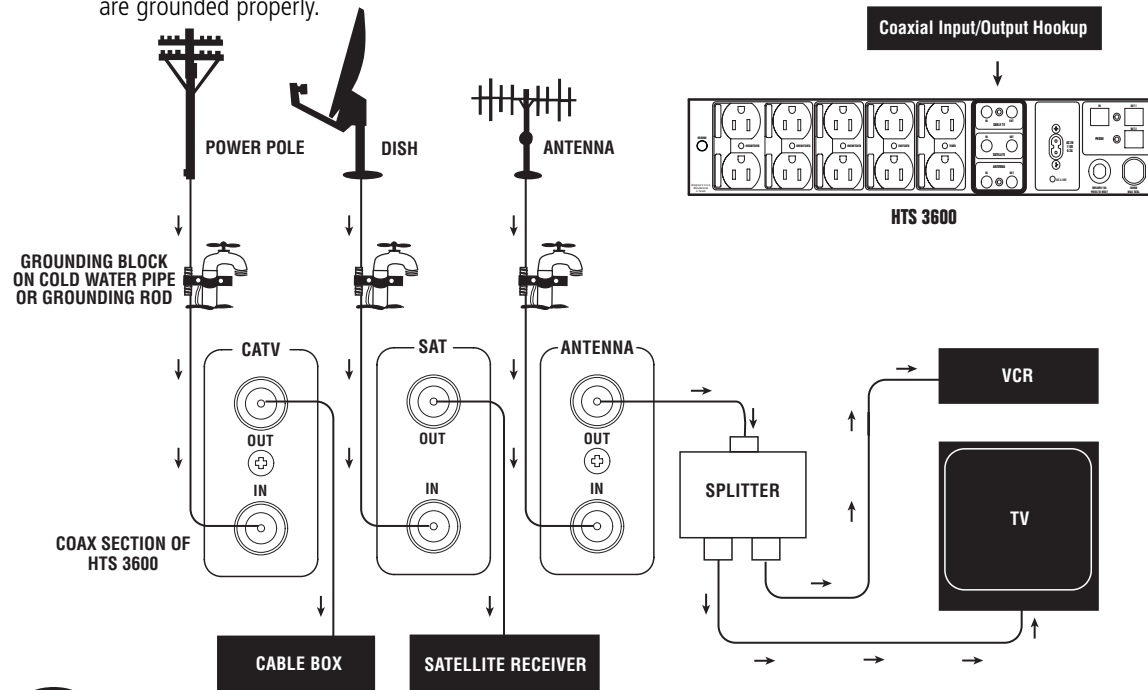

HTS 3600 FEATURES

PLEASE TURN TO PAGE 17 FOR DESCRIPTION OF PRODUCT FEATURES

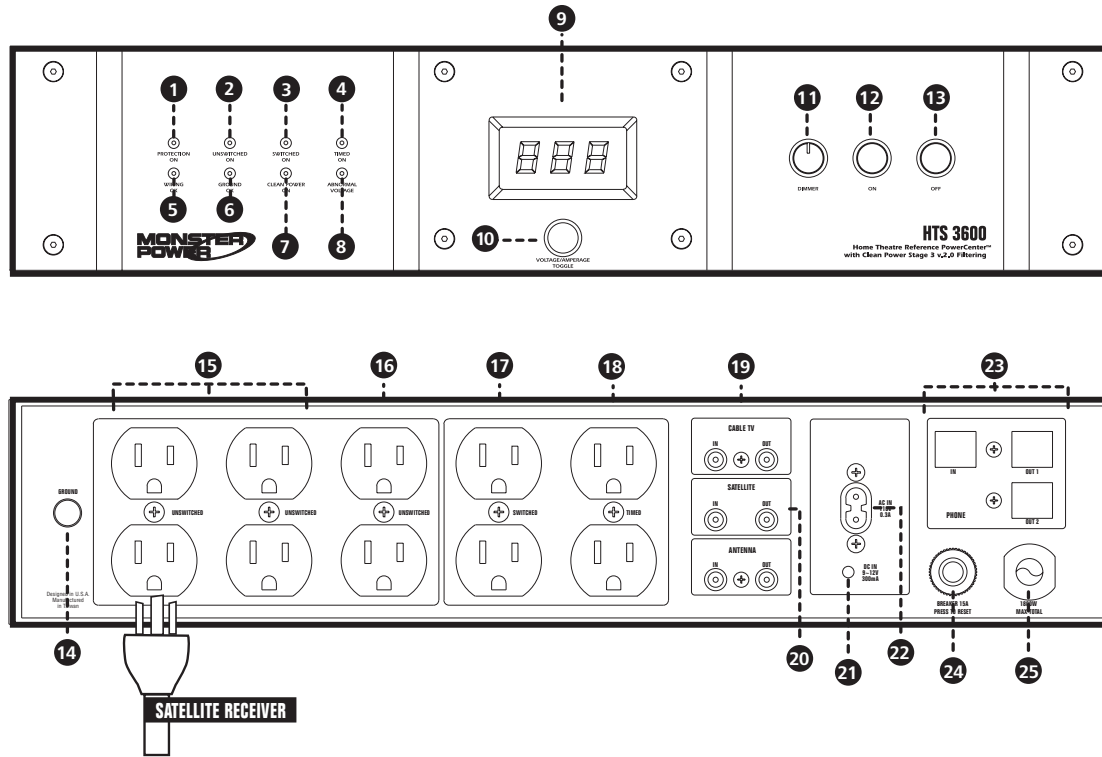

HTS 3600 FEATURES

NUMBERS REFER TO DRAWINGS ON PAGE 16

- 1. Protection On LED:** Indicates Monster Power Surge Protection Circuitry is functioning properly. If this LED is off, Monster Power Surge Protection Circuitry has malfunctioned. If the light is off, unplug the PowerCenter immediately. See warranty information for details on how to return damaged equipment to Monster Cable® (page 33).
- 2. Unswitched On LED:** Indicates power is being supplied to unswitched outlets.
- 3. Switched On LED:** Indicates power is being supplied to switched outlets.
- 4. Timed On LED:** Indicates power is being supplied to sequentially timed outlets.
- 5. Wiring OK LED:** Indicates that polarity is correct on AC lines. If the LED is off, unplug the HTS 3600 and consult an electrician.
- 6. Ground OK LED:** Indicates the PowerCenter is plugged into a properly grounded 120V AC power outlet. If the LED is Off, unplug the PowerCenter immediately. **Monster Cable® is not responsible for equipment damage due to improper grounding of your home's outlets.**
- 7. Clean Power On LED:** Indicates Monster Clean Power circuitry is functioning.
- 8. Abnormal Voltage LED:** Alerts user of potential power problems.
- 9. Multifunction Digital LED with Adjustable Illumination:** Measures incoming voltage or displays your system's current draw (display is controlled by voltage/ampereage toggle shown as #7 in product illustration).

NUMBERS REFER TO DRAWINGS ON PAGE 16

10. Voltage/Amperage Toggle: Allows you to view either the Input Voltage or System Current Draw LED Readout.

11. Dimmer Button: Adjusts the meter illumination or the amount of light to the Digital LED Readout.

12. ON Switch: Once the PowerCenter is plugged into a properly grounded 120V outlet, pressing this button will provide AC power to the components plugged into the PowerCenter's Switched and Switched (Timed) outlets.

13. OFF Switch: Press this button to shut down Switched and Switched (Timed) components.

14. Ground Screw: This screw provides a ground reference point, for any ungrounded components,

15. Digital Isolation Filter (Unswitched Outlets): These outlets have a special filter circuit that is designed to reduce interference to your digital components. Make sure to match the appropriate Identification Sticker to each component's power cord.

IMPORTANT NOTE It does not harm video components or audio components to be connected to the digital filter section. However, for the best possible performance, we recommend plugging in only digital components here.

16. Video Interference Reduction Filter (Unswitched Outlets): These outlets have a special filter circuit that is designed to reduce interference to your video components. Match the appropriate Identification Sticker to each component's power cord.

IMPORTANT NOTE It does not harm audio components or digital components to be connected to the video filter section. However, for the best possible performance, we recommend plugging in only video components here.

NUMBERS REFER TO DRAWINGS ON PAGE 16

17. Analog Audio Filter (Switched Outlets): These outlets have a special filter circuit that reduces audible noise in your audio components. Match the appropriate Identification Sticker to each component's power cord.

IMPORTANT NOTE It does not harm video components or digital components to be connected to the audio filter section. However, for the best possible performance, we recommend plugging in only audio components here.

18. High Current Audio Filter (Switched/Timed) Outlets: These outlets have a special filter circuit designed to handle high power audio components like amplifiers. Make sure to match the appropriate Identification Sticker to each component's power cord.

19. CATV Coaxial Input/Output: The input connects the coaxial cable from your cable TV company. The output connects the coaxial cable to input of your TV or VCR..

20. Satellite Coaxial Input/Output: The input connects the coaxial cable from your Satellite dish. The output connects the coaxial cable to your satellite receiver input.

21. Remote DC Control: For custom installation applications. Allows you to turn your PowerCenter On via the remote that operates your Custom Installation center.

22. Remote AC Control: Allows you to turn your PowerCenter On via the remote that operates one of your other components, such as your A/V receiver, for example.

IMPORTANT NOTE It does not harm video components or digital components to be connected to the ultra high current filter section. However, for the best possible performance, we recommend plugging in only high current audio components here.

NUMBERS REFER TO DRAWINGS ON PAGE 16

- 23. Phone Line:** Allows hookup of two lines simultaneously. Features a special Gas Surge Arrestor that protects against damaging voltage surges on the phone line.
- 24. Thermal Circuit Breaker:** Protects the PowerCenter from power overload.
- 25. Ultra High Current PowerLine™ 200 AC Power Cable:** High density double shielded AC Power cord is specially designed to maximize power transfer of ultra-high power components such as dedicated amplifiers.

TROUBLESHOOTING

PROBLEM – The PowerCenter is not receiving power.

Possible Cause #1

The PowerCenter is not turned On.

Possible Solutions

- *Turn the PowerCenter switch On.*
- *Make sure the PowerCenter's AC power plug is plugged into a properly grounded 120V wall outlet.*
- *In some households, a wall switch may need to be thrown to make the wall plug come alive. Try turning on the light switches located near the wall unit powering the PowerCenter.*

Possible Cause #2

Too many devices are connected, causing an overload, throwing the Thermal Circuit Breaker.

Possible Solutions

- *Press the PowerCenter Thermal Circuit Breaker button in to reset. Please allow 10 minutes before attempting to reset. If you reset too soon, the breaker will prematurely sense power overload and not allow unit to operate.*

TROUBLESHOOTING (continued)

Possible Cause #3

The PowerCenter cord is plugged into an outlet on the back of one of your components and the component is not turned On.

Possible Solutions

- *Turn the component power On.*

NOTE: For the best possible performance, plug the PowerCenter into a wall unit, not another component.

Possible Cause #4

PowerCenter is defective.

Possible Solutions

- *Please see the section marked "Warranty Information" for remedy (page 32).*

PROBLEM – PowerCenter is not receiving power.

Possible Cause #1

The component is plugged into an switched outlet and the PowerCenter has not been turned on.

Possible Solutions

- *Turn the PowerCenter On.*
- *Or, plug the component into an Unswitched outlet.*

TROUBLESHOOTING (continued)

Possible Cause #2

PowerCenter is plugged into a Switched outlet, but power on the component is not On. In some instances, a component plugged into a switched outlet won't receive power when the PowerCenter is turned On unless the component power is also switched On.

Possible Solution

- *Turn the component power On.*

PROBLEM – Speakers emit a humming or buzzing noise.

Possible Cause

The PowerCenter is sharing AC power with equipment that is not properly grounded.

Possible Solution

- *Connect your PowerCenter to a dedicated outlet.*

PROBLEM – The Unswitched LED on front panel is Off.

Possible Solution

- *Plug the PowerCenter into a properly grounded 120V outlet.*

TROUBLESHOOTING (continued)

PROBLEM – The Switched LED is Off.

Possible Cause #1

The component remote control you are using to power the Remote turn-on has a dead battery.

Possible Solution

- *Replace the battery powering the component remote control.*

Possible Cause #2

The component you wish to use to activate the Remote Turn-On isn't plugged into a properly grounded 120V outlet.

Possible Solution

- *Plug the component into a properly grounded 120V outlet.*

TROUBLESHOOTING (continued)

PROBLEM – Timed LED on front panel is Off.

Possible Cause #1

You are using the Timed Outlet Remote Turn-On feature (Same as Switched) and haven't plugged the two-prong cord into the component you wish to use to activate the Remote Turn-On.

Possible Solution

- *Plug the 2-prong cord into the component you wish to use to activate the Remote Turn-On.*

Possible Cause #2

The component remote control you are using to power the Remote turn-on has a dead battery.

Possible Solution

- *Replace the battery powering the component remote control.*

Possible Cause #3

The component you wish to use to activate the Remote Turn-On isn't plugged into a properly grounded 120V outlet.

Possible Solution

- *Plug the component you wish to use to activate the Remote Turn-On into a properly grounded 120V outlet.*

FREQUENTLY ASKED QUESTIONS

Q. What is the importance of component-to-component filtering?

A. With the Monster PowerCenter, AC power must first go through a segment of noise filters that isolate your equipment from noise on the AC power line. Most manufacturers' battle against line noise stops there. The next crucial step of noise filtering must occur between components. Our patent-pending component-to-component noise filtering is one of the PowerCenter's incredibly innovative features because it protects components from degrading each other's performance via their own special type of interference. The PowerCenter outlets are all directly connected, so the noise that's generated by a particularly noisy component (digital components like CD players are infamous for this) will attempt to get onto other components. It will not, however, because it must go through a specialized filter to get to an adjacent outlet, and noise is eliminated for the best possible sound and picture

Q. What is the importance of separate filtering for audio and video?

A. The nature of the audio and video signal is very different. Each application generates a different kind of noise and is sensitive to different types of noise. Video components generate a wide band of video interference. Audio components generate a narrow band of interference. Monster's patent-pending audio and video filters are optimized for each application, for maximum noise filtering.

Q. Does it matter which outlets I plug my components into?

A. Yes. Each group of outlets is specifically designed to protect and maximize performance of ONLY the components they are intended to power. For example, an amplifier is high current and a VCR is not. Each gets separate noise filtering to accommodate their inherent needs and differences. You would not want to leave an amplifier (high current) running all the time, so it is assigned a Switched outlet. A VCR on the other hand, is assigned an Unswitched outlet so you don't have to worry about setting and resetting that clock when PowerCenter is turned On and Off.

Q. Will it harm a component to plug it into an outlet that it's not designated to power, like a high current amplifier into an outlet marked for TV?

A. However, you may not realize the full performance potential of the PowerCenter. If you were to plug an amplifier into the Tape outlet, for example, you may experience a thumping noise when you turn on the PowerCenter. The amplifier is a high current device (TV is not) that ideally should be plugged into a PowerCenter Switched (Timed) outlet (which the TV outlet is not) to avoid this problem.

APPENDIX A

Glossary of Power-Related Terms

Audio Noise: In the audio-frequency range, any electrical disturbance introduced from a source extraneous to the signal.

Alternating Current (AC): A flow of electricity which reaches maximum in one direction, decreases to zero, then reverses itself and reaches maximum in the opposite direction. This cycle is repeated continuously.

Amp: A common abbreviation for Ampere. Ampere is a unit of electrical current or rate of flow of electrons.

CSA: A common abbreviation for Canadian Standards Association. CSA has developed over 200 standards, including several for electrical and electronic products.

Clean Power:[™] Noise filtering designed exclusively for Monster Power products by renowned engineer/inventor Richard Marsh. Filters out unwanted interference caused by RFI, EMI, and component-generated noise, so components plugged into a PowerCenter can deliver maximum performance without noise entering their signal path.

Conducted Noise: Any unwanted electrical signal conducted on the power lines supplying the equipment.

Current: The movement of electrons through a conductor.

Digital Noise: In the digital-frequency range, any electrical disturbance introduced from a source extraneous to the signal.

Direct Current (DC): A flow of continuous electric current in one direction.

Electromagnetic Interference (EMI): Electromagnetic phenomena in which various appliances and components generate interference that can contribute to a degradation in performance of an electronic receiver or system.

Filter: A selective network of resistors, inductors, or capacitors which offers comparatively little opposition to certain frequencies, while blocking or attenuating other frequencies.

Ground: A point in an electrical system that has zero voltage. Usually, the chassis of an electrical component is at ground potential and thus serves as the return path for signals as well as for power circuits.

Hertz (Hz): A unit of frequency equal to one cycle per second.

Joule Rating: A measurement of how much surge can be absorbed by a surge suppressor device. The higher the joule rating, the more surge it can absorb.

Peak Current: The maximum current which flows during a complete cycle without permanent change in breakdown ratings or published life specifications.

Power: The energy dissipated into an electrical or electronic circuit or component that is conducting either AC or DC. Electrical energy developed to do "work" such as the voltage from an amplifier used to drive a speaker.

Power Line: Two or more wires conducting electric power from one location to another.

Radio Frequency Interference: Any electrical signal capable of being propagated into and interfering with the proper operation of electrical or electronic equipment. The frequency range of such interference may be taken to include the entire electromagnetic spectrum.

Spike: An abrupt transient which comprises part of a pulse, but exceeds its average amplitude considerably.

Surge: A large, sudden change of voltage or current, usually caused by the collapse of a magnetic field or by a shortened or opened circuit element.

Surge Protector: A device which protects component circuitry from high alternating voltage peaks or transients.

Transient: A momentary surge on a signal or power line which may cause component breakdown and failure.

UL: A common abbreviation for Underwriters' Laboratories, Inc., a corporation supported by some underwriters for the purpose of establishing safety standards on types of equipment or components.

Video Noise: In the video-frequency range, any electrical disturbance introduced from a source extraneous to the signal.

Volt (V): The unit of measurement of electromotive force. One is equivalent to the force required to produce a current of one ampere through a resistance of one ohm.

Voltage: Electrical pressure—i.e., the force which causes current to flow through an electrical conductor.

Voltage Rating: The maximum voltage which an electrical device or component can sustain without breaking down.

APPENDIX B

Warranty Information

Monster Cable Products, Inc. warrants that this product shall be free of defects in materials and workmanship under normal use for 5 years from the date of purchase from an Authorized Monster Power Dealer.

This warranty extends only to the original purchaser and is nontransferable. During the warranty period, Monster Cable Products, Inc. will, at no additional charge, repair or replace defective parts or, at the option of Monster Cable Products, Inc., replace the entire unit.

This warranty does not extend to any Monster Cable Products, Inc. product that has been damaged or rendered defective (a) as a result of accident, misuse or abuse; (b) by the use of parts not manufactured or sold by Monster Cable Products, Inc.; or (c) by modification of product.

Connected Equipment Warranty

Monster Cable Products, Inc. will replace, or, at its option, pay to repair or pay the fair market value of equipment that is damaged by an AC power, cable, telephone, or lightning surge while connected to a properly installed Monster Cable Products surge protector, 5 years from the date of purchase from an Authorized Monster Power Dealer.

\$500,000 is the maximum amount Monster Cable Product, Inc. will pay. The foregoing Connected Equipment Warranty is conditioned on the damage having arisen from surge damage or the Monster Cable Products surge protector having operated outside the designed specifications.

GENERAL PROVISIONS

As To Each Warranty:

Any technical or other advice offered before or after delivery with respect to the use and application of the product is furnished without charge and subject to the understanding that such advice is issued at the purchaser's sole risk without any limitation or modifications of any disclaimer or other provision contained herein.

THE ABOVE ARE IN LIEU OF ALL OTHER WARRANTIES, EXPRESS OR IMPLIED, INCLUDING IMPLIED WARRANTY OF MERCHANTABILITY AND FITNESS FOR A PARTICULAR PURPOSE.

IN NO EVENT SHALL MONSTER CABLE PRODUCTS, INC. BE LIABLE FOR SPECIAL, INCIDENTAL, CONSEQUENTIAL OR INDIRECT DAMAGES.

CONNECTED EQUIPMENT CLAIM

How To Make A Claim

In the event damage has occurred to equipment which is properly connected to a Monster Power product as a result of an abnormally high voltage spike, you must follow these instructions.

1. Call 877/800-8989.
2. Give a detailed explanation of how the damage occurred.
3. Obtain a Return Authorization number for the Monster Power product.
4. A "Connected Equipment Claim Form" will be sent to you. This claim form must be filled out entirely and sent back with the Monster Power product.
5. Return the Monster Power product, shipping prepaid, to Monster for verification of damage, along with a copy of your sales receipt for your Monster Power product, completed Connected Equipment Claim Form, and Return Authorization number printed on the outside of the package. The Connected Equipment Claim Form will include complete instructions for return.
6. Monster will respond as to whether the damage to the connected equipment was caused by the Monster Power product.

7. If it is determined that the damage was caused by the Monster Power product, Monster, at its discretion, will direct you to:
 - A. Obtain a repair estimate at a service center authorized by the manufacturer of the connected equipment; or,
 - B. Send the connected equipment to Monster for repair; or,
 - C. Reimburse you for the fair market value of the damaged connected equipment (see Limited Connected Equipment Warranty for details).
8. If a repair estimate is required, as stated in Section 7A above, you will be instructed on how to properly submit Monster for payment.

Note: Compensation for or restoration of data loss is not covered.

If you have any questions regarding this claim procedure, call 877/800-8989.

APPENDIX C

How to Contact Us

Write to us at: Monster Power
C/O Monster Cable Products, Inc.
455 Valley Drive
Brisbane, CA 94005

Visit us on the web at: monstercable.com

Call us toll-free at: 877/800-8989.

▲ Please Tear the Return Registration Card Out of the Manual Here ▲

Register Your Product For Warranty Coverage

Please either complete and return this warranty registration by mail, or go to monstercable.com/warranty to register online

Name (please print) _____ Age _____

Address _____

City/State/Country _____

Zip/Postal Code _____ Email Address _____

Daytime Phone Number (with area and/or country code) _____

Evening Phone Number (with area and/or country code) _____

Name and Location of Dealer _____

Monster Power Model Purchased _____ Serial Number _____

Other Monster Power and/or Monster Cable Products Used _____

1. How did you hear about Monster Power?

- Salesperson Friend Newspaper/Magazine Advertisement Newspaper/Magazine Story or Review
 In-Store Display Other _____

2. Estimated value of your entire system?

- Under \$1,000 \$1,000–3,000 \$3,000–5,000 \$5,000–10,000 Over \$10,000

3. What is your favorite music?

- Classic Rock Alternative Classical R&B Rap Country New Age Instrumental Jazz Blues Pop Oldies
 Other _____

4. Did you buy this Monster PowerCenter with a new system or component? Yes No

Please see other side ►

5. Was this Monster PowerCenter a gift? Yes No

6. What was the purchase price of this unit? _____

7. How would you describe your experience when purchasing this product?

The salesperson was knowledgeable and helpful The salesperson was not knowledgeable about Monster Power products

I knew exactly what I wanted and didn't need any help with my decision Not applicable Other _____

8. Approximately how many times have you purchased Monster Power products?

This is the first time Two Three Four Five More than five

9. How would you describe Monster PowerCenter's contribution to your system?

I never tried it any other way It made no difference at all I noticed a slight improvement I am impressed. It made a big improvement

I can't believe it! Is this the same system?

10. What audio, video or music magazines do you read?

Fi Magazine Stereophile Audio Stereo Review Home Theater Audio Video Interiors Video Absolute Sound

Stereophile's Guide to Home Theatre Widescreen Review Other _____

11. Annual household income?

Under \$25,000 \$25,000–50,000 \$51,000–100,000 Over \$100,000

12. Age? Under 18 18–34 34–49 49–59 59–69 69–79 Over 79

13. Have you made any purchases through the mail in the last twelve months? Yes No

14. Male Female

15. Do you rent... DVDs Video Tapes Laser Discs

16. Do you buy... DVDs Video Tapes Laser Discs

17. If you could suggest a new Monster Power product or an improvement to one or more of our existing products, what would it be? _____

Please return warranty registration to: **Monster Power®**
455 Valley Drive
Brisbane, CA 94005

NOTES

NOTES



A division of The Monster Group™
455 Valley Drive • Brisbane • CA 94005

Come Visit Us At: monstercable.com

The Monster Power Home Theatre Reference PowerCenter HTS 3600 is protected
under U.S. Pat. No. 5,589,718. Other Patents Pending.

inv. no. 151008

© Monster Cable 2001 All Rights Reserved
"Monster Cable" "Monster Power" "Monster" "Clean Power" "PowerLine" and "PowerCenter"
are registered and unregistered trademarks of Monster Cable Products, Inc.