

SI-1230



Systems Integration Amplifier™



CONGRATULATIONS!

Thank you for purchasing the award winning Niles SI-1230, one of the most versatile and powerful multi-channel amplifiers ever offered. Like all Niles products, the SI-1230 is built to the highest standards of quality and reliability. With proper installation and operation, you'll enjoy years of trouble-free use.

Niles manufactures the industry's most complete line of custom installation components and accessories for audio/video systems. For a free full-line catalog write: **Niles, Catalog Request, P.O. Box 160818, Miami, Florida 33116-0818**

TABLE OF CONTENTS

INTRODUCTION	2
FEATURES AND BENEFITS	3
APPLICATIONS AND SYSTEM DESIGN CONSIDERATIONS	5
CONFIGURING YOUR SYSTEM	12
INSTALLATION CONSIDERATIONS	13
FRONT AND REAR PANEL DETAILS	15
INSTALLATION	19
OPERATION	25
TROUBLESHOOTING GUIDE	27
CONFIGURATION WORKSHEET	29
SPECIFICATIONS	30



The lightning flash with arrowhead symbol, within an equilateral triangle, is intended to alert the user to the presence of uninsulated dangerous voltage within the product's enclosure that may be of sufficient magnitude to constitute a risk of electric shock to persons.



The exclamation point within an equivalent triangle is intended to alert the user to the presence of important operating and maintenance (servicing) instructions in the literature accompanying the appliance.

INTRODUCTION

We call the SI-1230 a Systems Integration Amplifier because, for the first time, a power amplifier has been specifically designed to solve the problems of interfacing with different brands and models of equipment, different acoustic environments in different rooms, and different kinds of applications: home theater, stereo, and background music. As you read this manual and become more familiar with the capabilities of the SI-1230 you'll understand why its predecessor, the SI-1200, was selected Best New Product 1994 by Sound & Video Contractor Magazine and CEDIA (Custom Electronic Design and Installation Association). In addition, the SI-1200 also won the Consumer Electronics Show's Innovations '95 Design and Engineering Award.



SI-1230
Systems Integration Amplifier



**CEDIA and Sound & Video Contractor
Magazine Best New Product 1994 Award**



FEATURES AND BENEFITS

Real World Power

The SI-1230 is a 12-channel amplifier that delivers a solid 30 watts per channel RMS into 8 ohms and 37 watts per channel RMS into 4 ohms. The massive Multi-Tap Toroid power transformer features six independent secondary transformers for each of the six amplifier modules. As a result, the SI-1230 delivers twenty percent more power than its predecessor, the SI-1200. This extraordinary power supply design provides the energy necessary to deliver solid, deep, controlled bass response to a house full of speakers.

Twelve to Six Channel Configurable Power

Each of the SI-1230's six adjacent output pairs are bridgeable. You can create up to six 80 watt channels by sliding the bridging switches located between each pair to the "bridged" position. This enables you to allocate more power to specific locations, such as large rooms or outdoor applications.

Freedom from Noise and Cross-Talk

The SI-1230's Input/BusMatrix™ PC board incorporates advanced construction ensuring extremely high channel to channel isolation. Signal to noise ratios and cross-talk are equivalent to a professional mixing board found in a recording studio. With the SI-1230 the music playing in the living room cannot interfere with the music in the den.

Transparent Sound

The audio circuitry of the SI-1230 is constructed with the finest parts available, including 1% metal film resistors, high quality capacitors and oversized heat sinks. All this attention to technical detail results in a sound that is clear and uncolored.

BusMatrix™ Selector

Our unique BusMatrix selector gives you the flexibility to assign each channel to a common Left, Right, or Mono signal bus, or to a dedicated signal input. With BusMatrix, routing surround sound to the master bedroom, stereo to the den and mono to the powder room is as simple as flicking a switch. BusMatrix makes the SI-1230 an ideal multi-room or multi-zone amplifier and offers exciting new features and system design possibilities to the professional installer.

Independent Level Controls

Each channel has its own independent level control enabling you to adjust the volume settings for twelve different speaker locations. Each speaker can be adjusted for its location and who uses it!

Turn-On Modes

The SI-1230 features three turn-on modes: 1. Manual turn-on via the front panel switch, 2. Audio Sense and 3. External Voltage trigger. Audio Sense and External Voltage trigger modes enable allow you to configure the SI-1230 to interface with any kind of system and turn on automatically.

Automatic Protection

Each channel has independent thermal and short circuit protection. In the unlikely event that a problem occurs on one channel, the other channels will continue to play. When conditions return to normal, regular operation resumes.

Status Display for Troubleshooting

LED's on the front panel indicate Power, Active and Protection Status. With a glance at the front panel a troubleshooter is quickly provided with key information!

Made in the USA.

Limited two year parts and labor Warranty.

APPLICATIONS AND SYSTEM DESIGN CONSIDERATIONS

- 5 System Design Basics—Assigning Rooms to Zones
- 6 Advantages of using the SI-1230 in a Single Zone System
- 7 Using Level Controls as Limiters
- 7 Bridging Channels for Areas That Require More Volume and Power
- 8 Using Mono for Smoother Coverage
- 8 Adding More Than Two Surround Sound Speakers
- 9 Creating a Low-Cost Second Zone Using a Dedicated Source
- 10 Adding Preamps to Create More Listening Zones
- 11 Surround Sound in Two Rooms

System Design Basics—Assigning Rooms to Zones

You define a multi-room music system by how many listening zones it has. Within a listening zone you can only listen to one source (CD, radio, tape, etc.) at a time. A zone can consist of just one room or a group of rooms. To achieve different volumes and greater convenience in different rooms within a zone, individual volume controls can be used. Niles makes volume controls in various styles and colors. Consult your local Niles dealer for more information.

When designing your system, take into account who will use the system and when they will use it. For example, a family might wire their family room for surround sound and their living room for background music.

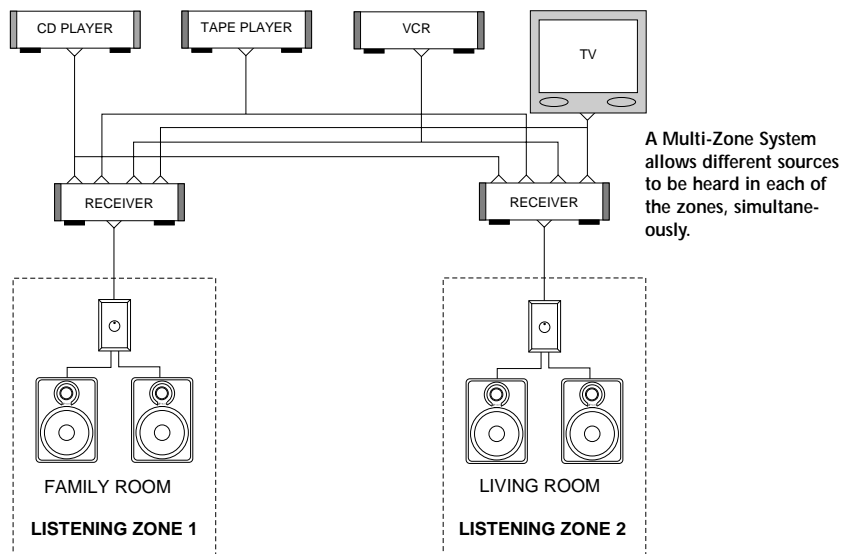

A Single-Zone System allows only one source to be heard throughout the house at a given time. However, if the system is configured to be a Multi zone system it would offer the household more flexibility. In a two-zone system, the children could watch TV in surround sound while Mom and Dad read the paper and listen to music in the living room.

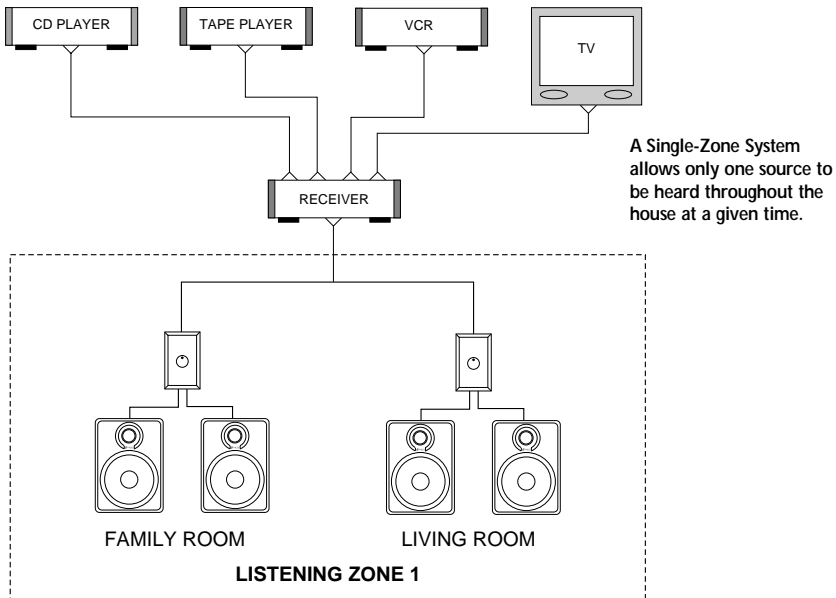

Advantages of using the SI-1230 in a Single Zone System

In order to connect multiple pairs of speakers to a single stereo amplifier, they must connect in parallel to offer the best sound quality and to allow the convenience of an individual room volume control. Because parallel connections of multiple speaker pairs lower the overall impedance presented to an amplifier, damage may occur. An impedance matching device will allow amplifiers to safely play multiple pairs of speakers. However, the amount of power actually delivered to the speakers when all of the speakers are playing simultaneously is very low. Typically a 100 watt stereo amplifier with an impedance matching device will deliver about 5 watts to each speaker in a system comprised of six pairs of eight ohm speakers. By connecting an SI-1230 to the preamplifier outputs of your stereo receiver (or preamp) you dedicate a robust 30 watts to each speaker in your multi-room system. Since each channel has its own level control, you can compensate for architectural differences that create sonic imbalances. In addition, you can fine tune the system so that when all of the room volume controls are set to the loudest level, the large rooms and the small rooms play at the same volume.

Using Level Controls as Limiters

If your system is remote controlled, or if you think that some of the users like to play the stereo too loudly, you can choose to calibrate the system so that it is limited to a volume level you assign. The SI-1230 allows you to set different volume levels for different rooms.

Calibrate your system volume levels with the steps outlined below:

1. Lower all of the SI-1230 level controls to the minimum volume position. If there are any other amplifiers in the system, lower their level controls to the minimum (all of the amplifiers in your system must have level controls).
2. Raise all of the individual in-wall volume controls to the loudest setting.
3. Play a loud radio station with the tuner set to Mono.
4. Raise the volume of your preamplifier or receiver slowly— if you hear any sound, lower the volume again and recheck all of your amplifier levels, they must be at minimum. If no sound is heard, proceed to step five.
5. Have someone step into each room and listen as you adjust each level control to the desired maximum level for that room. Adjust the balance between speakers for the most common listening position in each room.

Bridging Channels for Areas That Require More Volume and Power

There are several situations where bridging is an excellent way to improve the sound. Likewise, there are some applications that would seem to be appropriate but are not recommended. Plan to bridge channels to increase the power to 80 watts per channel when required. Here are some of the most common DO'S and DON'TS:

Surround Sound Systems (DO)– The dynamic demands for the center channel are much higher than the left, right or surround channels. This is an excellent application for two channels to be bridged into one 80 watt channel.

Outdoors (DO)– Sound dissipates faster outside than within a room where the walls enclose the sound and reflect it back to the listener. A pair of speakers playing into a large patio or yard will greatly benefit from bridging four channels into two 80 watt channels.

More than Two Speakers (DON'T)– In a large room or a long hallway, you will often find that the best way to get good background music is to install multiple pairs of speakers. You will actually deliver more power to four eight ohm speakers by using two unbridged channels than you would if you bridged four channels into two. An unbridged channel is stable down to four ohms (two pair of eight ohm speakers), but a bridged channel is only useful with an eight ohm load.

Using Mono For Smoother Coverage

In a large or irregularly shaped room you will often discover that in a particular chair, all you can hear is one speaker. If the room's speakers are connected to a stereo amplifier you hear only half the music. The solution would be to connect that room's speakers to a monophonic amplifier. However, if you make one room mono with conventional systems, all of the other rooms in the system are mono as well. For the first time, the SI-1230's BusMatrix enables you to route mono to one speaker without affecting the quality of the stereo in the rest of the system. You can configure each room to stereo or mono with no ill effects. Some of the most popular areas where mono will greatly enhance the quality of the sound would be:

1. Large rooms with many seating areas and/or many pairs of speakers
2. Irregularly shaped rooms
3. Bathrooms with one speaker over the tub and one speaker over the sink(s)
4. Hallways or passageways (even those with multiple speakers)
5. Small rooms where only one speaker will physically fit

Adding More than Two Surround Sound Speakers

In a home theater, we try to reproduce the experience of a great movie theater in our homes. The biggest difference between a commercial theater and your home is the rear or surround speaker array. In a home with a single pair of speakers it is easy for the surround effects to sound like they are "in the middle of your head", just like headphones!

The best way to create a strong "surround" effect is to use multiple speakers. In large or unusually shaped rooms this might be the only way to achieve good sound. However, the built-in surround amplifier channels of a typical receiver will not successfully power more than one pair of speakers. If your surround processor or receiver has rear pre-outputs you can easily improve the surround effect with additional speakers and one or two channels of an SI-1230. The individual level controls of the SI-1230 allow six decibels of gain over the main and center amplifiers for easy calibration of a mix of brands/models of speakers.

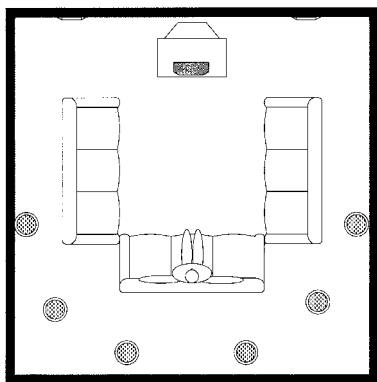

Additional surround speakers fed by the SI-1230 greatly enhance the effectiveness of your surround sound system.

Creating a Low-Cost Second Zone Using A Dedicated Source

The biggest problem in a single zone system is that when the TV is in use in one room, you cannot listen to music in another room. For a listener who only listens to CD's it is possible to create a low-cost second zone, allowing simultaneous CD listening while the rest of the system plays the TV (or any source). This is possible with the advent of CD players which have two audio outputs; one variable and controlled via remote control and one which is fixed. You connect the variable output of the CD player to the SI-1230 channels for a particular room where you are willing to listen only to CD's. The fixed outputs remain connected to the main preamp or receiver so that you can listen to CD's in the rest of the house. The crowning touch is a Niles remote control repeater system so that you can raise and lower the CD player's volume from your CD listening room.

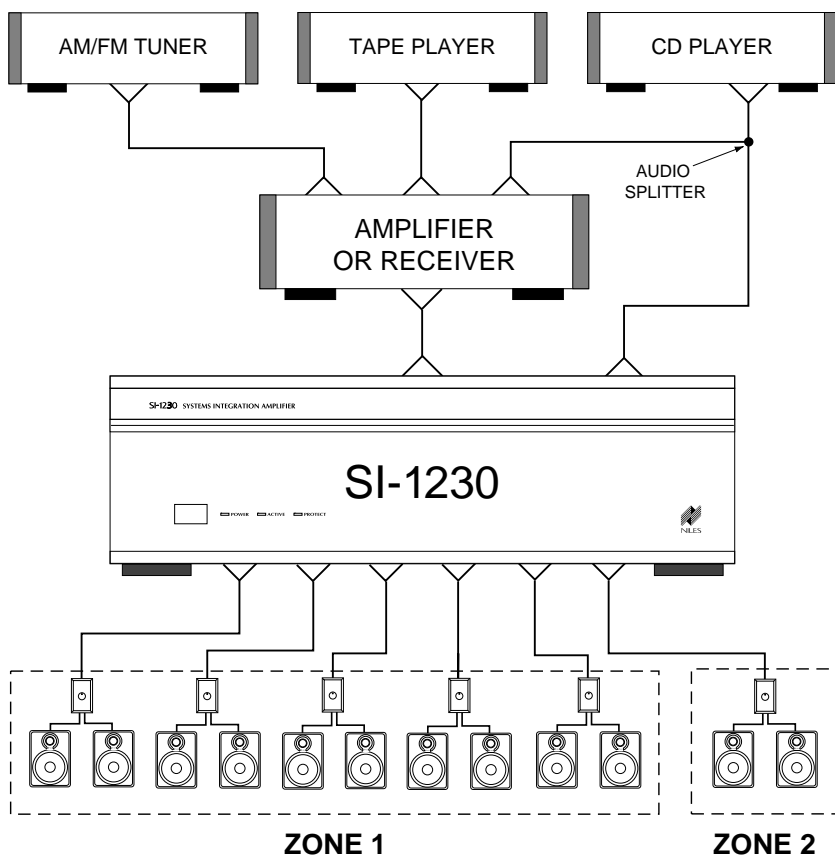

Adding Preamps to Create More Listening Zones

In the ultimate multi-zone system you would connect six stereo preamplifiers (or a single component multi-zone or matrix preamp) to one SI-1230 and create six completely independent stereo systems. A system like this allows six people to simultaneously listen to different sources. Since the SI-1230 and the wiring of your house is already capable of a system like this, you can easily upgrade the number of zones in your system by simply adding another preamplifier and changing the connections to the SI-1230.

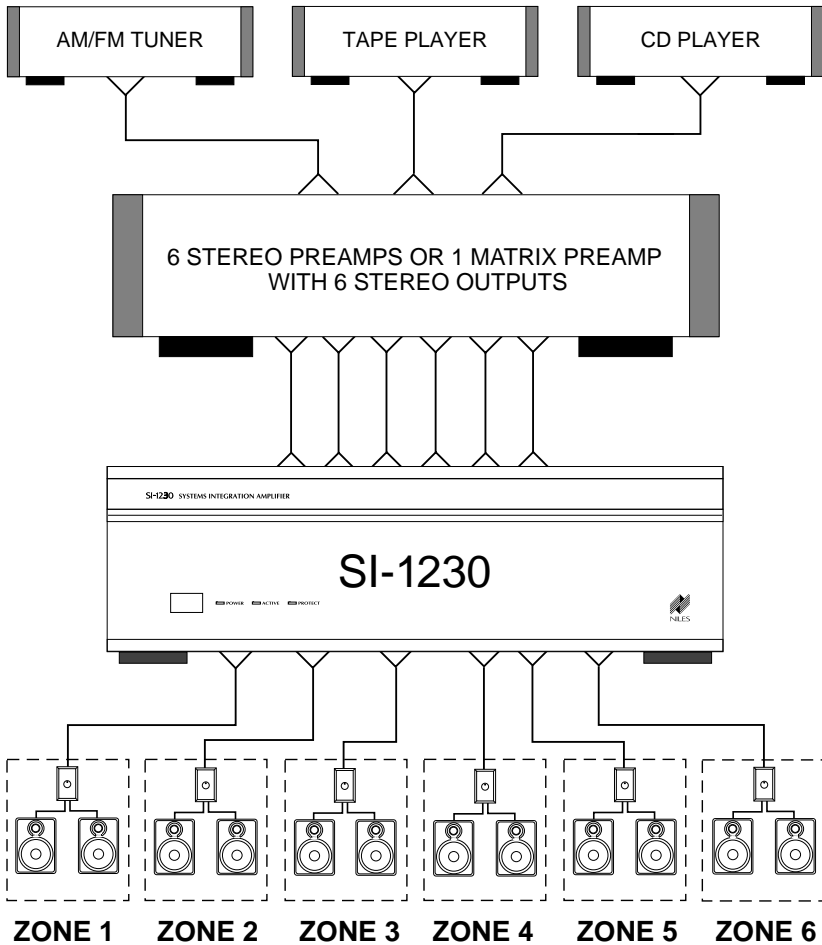

Surround Sound in Two Rooms

You can easily add a second room of surround sound speakers by connecting five of the SI-1230 channels to the pre-outs of your surround system. If there is a pre-out/main-in loop, use a "Y" connector as shown so that the internal power amplifier can still be used in the main surround sound room. When you configure a system for a second surround sound room, consider bridging the center channel amplifier to 80 watts if the listener prefers high volumes. The center channel performs 60 to 80 percent of the dynamics of a movie soundtrack.

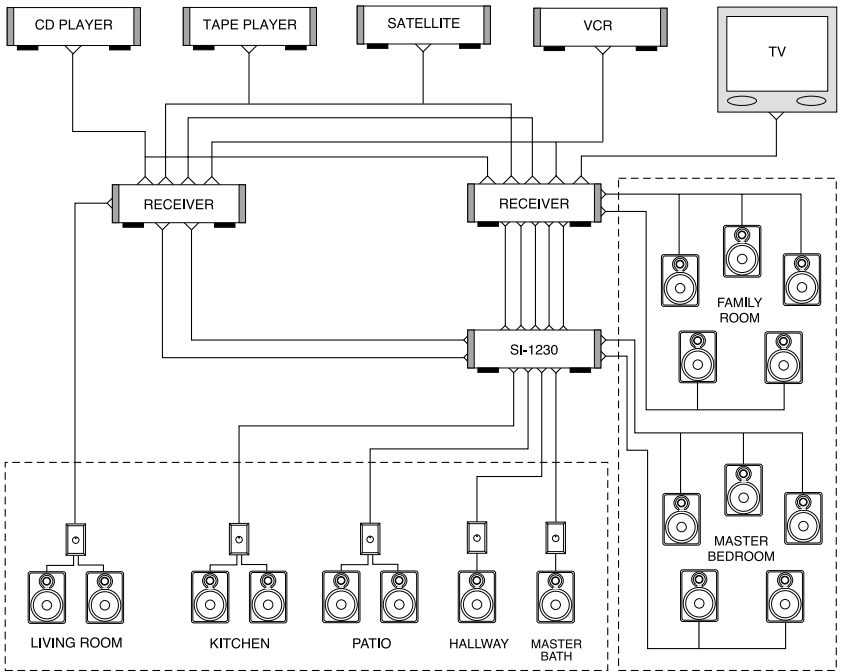

In this two-zone, six room system, a Surround Receiver, a Stereo Receiver and the SI-1230 combine to provide great sound everywhere. The stereo receiver plays in the Living Room, the surround receiver plays in the Family room and the SI-1230 simultaneously plays Dolby Pro-Logic Surround Sound (with a bridged center channel) in the Master Bedroom, stereo in the Kitchen and Patio, and mono in the Master Bath and the Front Hall.

CONFIGURING YOUR SYSTEM

Because the SI-1230 offers so many configuration possibilities it is important to plan carefully before you install it. Draw a block diagram of your system and use the Configuration Worksheet on page 29 to record how you plan to connect your SI-1230. Here is an example filled out according to the block diagram on page 11.

Sample Configuration Worksheet

BUS INS & OUTS		CONNECTED TO		
Left Main Bus		<i>Stereo Receiver Left Pre-Output</i>		
Right Main Bus		<i>Stereo Receiver Right Pre-Output</i>		
Cascade Output		<i>Looped back into the Stereo Receiver's Main Inputs</i>		
CH #	BRIDGED	DIP	INPUT SOURCE	SPEAKER
1	<input type="checkbox"/>	L	<i>Main Bus</i>	<i>Left Kitchen</i>
2		R	<i>Main Bus</i>	<i>Right Kitchen</i>
3	<input type="checkbox"/>	L	<i>Main Bus</i>	<i>Left Patio</i>
4		R	<i>Main Bus</i>	<i>Right Patio</i>
5	<input type="checkbox"/>	L+R	<i>Main Bus</i>	<i>Front Hall</i>
6		L+R	<i>Main Bus</i>	<i>Bathroom</i>
7	<input checked="" type="checkbox"/>	Off ^o	<i>(Bridged.)</i>	<i>Bedroom Center +</i>
8		8	<i>Receiver Center Pre-Out</i>	<i>Bedroom Center -</i>
9	<input type="checkbox"/>	9	<i>Receiver Left Main Pre-Out</i>	<i>Bedroom Left</i>
10		10	<i>Receiver Right Main Pre-Out</i>	<i>Bedroom Right</i>
11	<input type="checkbox"/>	11	<i>Receiver Left Rear Pre-Out</i>	<i>Bedroom Left Rear</i>
12		12	<i>Receiver Right Rear Pre-Out</i>	<i>Bedroom Right Rear</i>
MODE SETTINGS		IN USE	SPECIAL CONNECTIONS OR NOTES	
Constant		<input type="checkbox"/>		
Audio Sense		<input checked="" type="checkbox"/>		
Voltage Trigger		<input type="checkbox"/>		
Control Output		<input type="checkbox"/>		

INSTALLATION CONSIDERATIONS

Placement

Place the SI-1230 on a flat, level surface like a table or shelf. It should be placed upright so that its weight rests on the unit's four feet. **PLACING THE WEIGHT OF THE AMPLIFIER ON THE REAR OR FRONT PANEL FOR EVEN AN INSTANT WILL RESULT IN DAMAGE TO THE AMPLIFIER'S CONNECTORS AND CONTROLS.**

The SI-1230, like any hi-fi component, will last much longer if it is given adequate ventilation for proper cooling. When installing the SI-1230 in a cabinet, be sure that the rear of the cabinet is open to fresh air to provide proper cooling (see **Figure 1**). If the cabinet's design will not accommodate an open rear, install two small "boxer fans" to provide continuous air flow into and out of the cabinet (see **Figure 2**). Place the SI-1230 so that there is at least 5" of free air space above the chassis. If the amplifier is located on a carpeted surface, place a board under the amplifier's feet. Do not block the ventilation holes on the top and bottom of the SI-1230.

The SI-1230 is equipped with a massive toroidal power transformer. This transformer generates a powerful magnetic field which could induce hum in a turntable (particularly a turntable equipped with a moving coil cartridge). Do not place a turntable directly above or directly adjacent to the SI-1230.

Figure 1

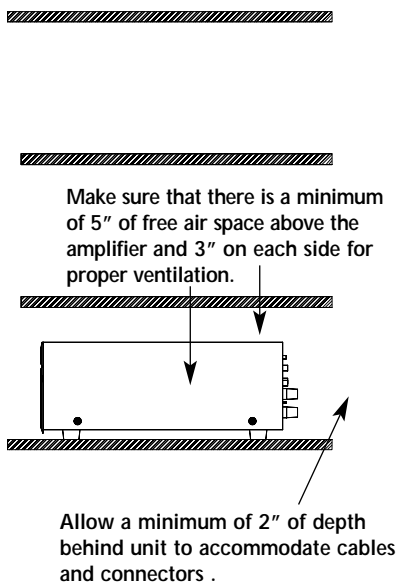
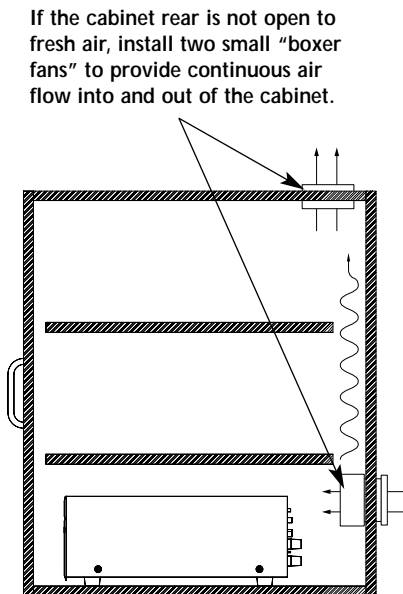

Figure 2



Turn-On Modes

The SI-1230 draws more current than a preamplifier's switched AC outlet can safely supply. Also, your preamplifier may "thump" at dangerous volumes if the amplifier is already on when the preamp turns on. It is usually best to turn the amplifier on only when it is needed. The Turn-On Mode selector switch gives you three options for turning "On" and "Off" the SI-1230.

Constant – The auto turn-on circuitry is off. The front panel master power switch operates the amplifier. In is "On", Out is "Off".

Audio Sense – The master switch on the front panel must be in the "On" position. The amplifier is off when there is no audio signal present at any of the 14 inputs, but the sensing circuitry is on. The turn-on sensing circuitry looks for a tiny amount of audio signal present at any of the audio inputs. If it detects a signal, the adjacent pair of amplifier channels (i.e. channel 1 & 2, 3 & 4, 5 & 6, etc.) assigned to receive the input signals will turn on. Once the audio signal stops, the sensing circuit waits two minutes, then turns all amplifier channels off.

3-30 Volt AC/DC Opto-Isolated Voltage Trigger – The master switch on the front panel must be in the "On" position. The amplifier is off when there is not a 3-30V AC or DC voltage applied to the voltage trigger input. Once the sensing circuitry detects a voltage, all adjacent pairs of amplifier channels that are receiving an audio signal turn on. Once the voltage stops, the sensing circuit instantly turns the amplifier off. Voltage triggers can be supplied by Niles automated switchers, some video projectors, some surround sound processors, or something as simple as a 16 volt AC wall adapter (Niles XF00008) plugged into the switched outlet of your stereo receiver. Do not use a DC wall adapter. The long discharge time of the DC adapter's filter capacitor will delay the turn-off of the amplifier.

If you are using a wall adapter or external power supply to provide the trigger it doesn't have to be very large (a minimum current capability of 2.5 milliamps for a 3 volt trigger increasing up to a minimum of 38 milliamps for a 30 volt trigger).

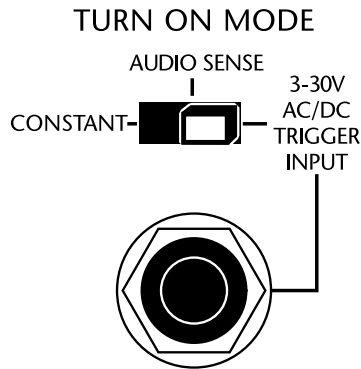

Red "Power" LED confirms the amplifier is connected to a live AC power outlet and that the front panel master power switch is on.

Red "Active" LED lights when the amplifier circuitry has been turned on by the Turn-On circuits.

Front panel "Master Power" switch turns off the entire amplifier, including the auto turn-on circuitry.

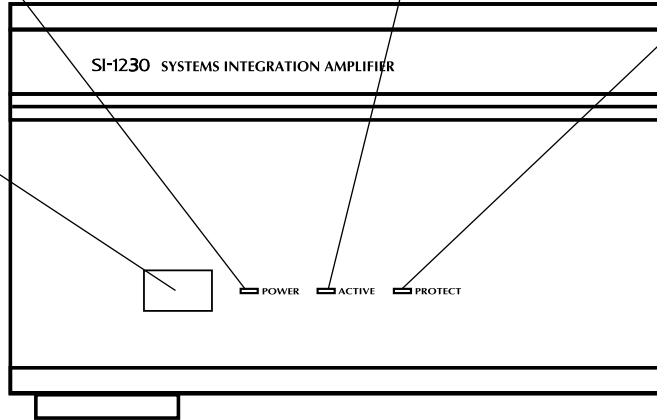

Main Bus Inputs enable you to route a stereo line level source to the BusMatrix™ of the SI-1230.

Cascade outputs of the main bus input enable you to daisy chain multiple amplifiers.

Bridging switch inputs and level controls.

"Turn-On" Mode Switch

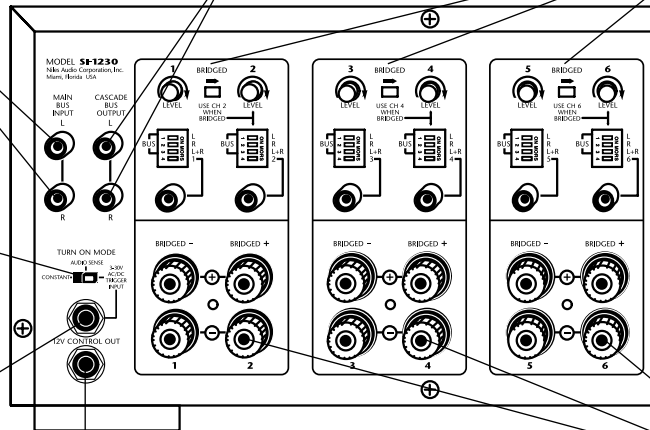

3.5 mm Jack for 12v DC Control Input.

3.5 mm Jack for 12v DC Control Output.

Red "protect" LED indicates a fault condition (D.C. output).

Attractive extruded aluminum front panel.

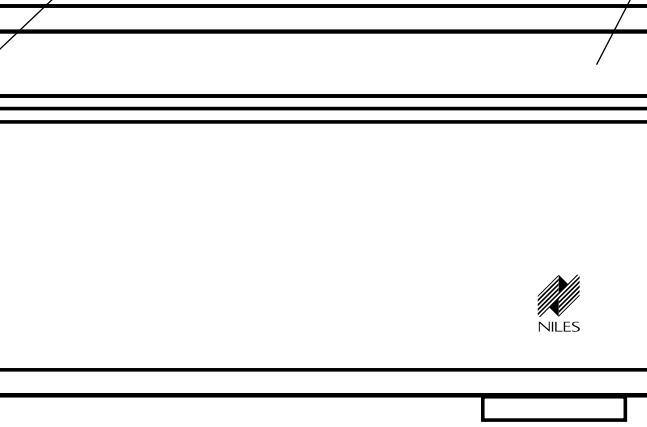

...es, BusMatrix controls, dedicated
...el controls for each channel.

Gold-plated
RCA jacks

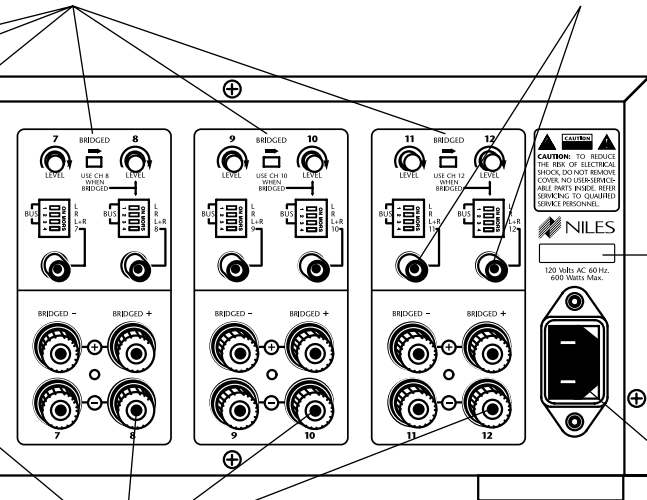

Serial Number.

Dual banana spaced binding
posts for speaker connections.

Removable Two-prong
16 gauge 6' AC power cord.

Speaker Compatibility

CAUTION! Do not use speakers with an impedance of less than **4 ohms** with an **unbridged** channel. Do not use speakers with an impedance of less than **8 ohms** with a **bridged** channel.

An unbridged channel of the SI-1230 is designed to play into a speaker load of four ohms or more. When a four ohm speaker is connected, the continuous power rating of the amplifier increases to 37 watts RMS per channel, (all channels driven). If the load is less than four ohms the protection circuits may operate and shut off the channel at higher volume levels.

A bridged channel requires that the load be eight ohms or more to deliver 80 watts RMS. If the load is less than 8 ohms the protection circuits may operate and shut off the channel at higher volume levels.

When designing your system try to specify four to eight ohm speakers (Niles offers a complete line of architectural loudspeakers with several models rated at 8 ohms).

Cable and Wire

Because the SI-1230 has so many connections on the back panel it is very important that you label all the input cables and speaker wires. If you label the cables and wires for their destination or source, rather than which terminal of the SI-1230 they are connected to, it will be easier to reconfigure your system in the future.

The SI-1230 connects to your sources via shielded line level audio cables with RCA phono plugs. Use high quality cables with your Niles amplifier for the lowest possible noise and best overall performance. Your Niles dealer can recommend the proper cable.

The SI-1230 connects to your speakers using 2-conductor speaker wire. For most applications, we recommend you use 16 or 18 gauge wire. For wiring runs longer than 80 feet we recommend 14 gauge wire. The binding posts of the SI-1230 will accommodate up to 12 gauge wire. Larger sizes can be accommodated by attaching banana plugs to the wire. Note that the binding posts do accept dual banana connectors, as well as single connectors. Niles Banana Plugs are available from your Niles dealer.

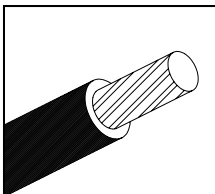

TECH TIP

Wire size is expressed by its AWG (American Wire Gauge) number. The lower the number, the larger the wire, i.e. twelve AWG is physically larger than fourteen AWG.

INSTALLATION

- 19 Bridging Two Channels into One
- 20 BusMatrix™ Input Switch Setting
- 21 Setting The Turn-On Mode Switch
- 21 The Control Output
- 22 Speaker Wire Connections
- 23 Line Level Audio Inputs
- 23 Cascade Audio Outputs
- 24 AC Power Plug
- 24 Rail Fuse Holders

CAUTION! ALL CONNECTIONS AND REAR PANEL SWITCH SETTINGS SHOULD BE MADE WITH THE AMPLIFIER'S FRONT PANEL MASTER POWER SWITCH OFF.

Bridging Two Channels into One

The SI-1230's bridging switches allow you to create a more powerful amplifier channel by combining or "bridging" two adjacent channels.

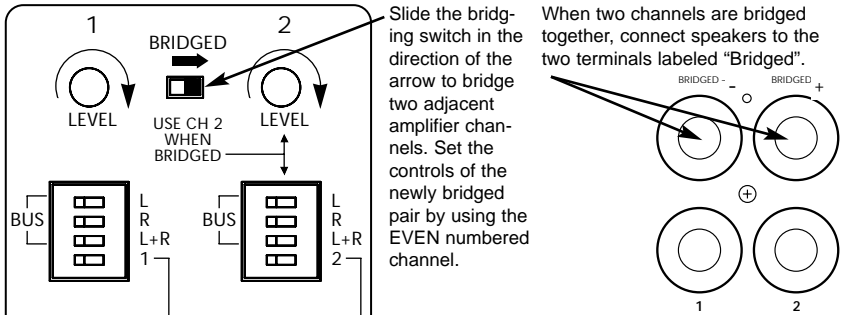

STEP	DESCRIPTION
<p>1. Choose which of the six pairs you wish to bridge and move the bridging switch for that pair to the "Bridged" position (toward arrow).</p>	<p>The 12 channels are grouped into 6 pairs (e.g. 1 & 2). Only the two channels within a pair can be bridged. Thus, only channels 1 and 2, or channels 3 and 4 could be bridged. You cannot bridge 2 and 3 for example.</p>
<p>CAUTION! Do not connect a speaker load of less than eight ohms to a bridged channel.</p>	<p>A bridged channel on a SI-1230 is designed for an eight ohm minimum load. Connecting a speaker with a nominal impedance of less than 8 ohms may cause the SI-1230 to go into protection or be damaged.</p>

Bridging Two Channels Into One (continued)

STEP	DESCRIPTION
2. Connect the speaker wires to the two Bridged speaker terminals (BRIDGED +, BRIDGED -). Observe proper polarity markings.	Connect your speaker wire only to the red terminals of the two adjacent amplifier channels. If one of the speaker wires touches a black terminal (thereby grounding the red "hot" terminals) you will short circuit the amplifier.
CAUTION! DO NOT connect a speaker selector or headphone junction box to the output of a bridged channel pair.	These connections to a bridged channel pair will result in either thermal shutdown or poor quality sound.
3. Use the EVEN NUMBERED input, input DIP switch, and level control for connections and configuration.	When two channels are bridged into one, make sure that the odd numbered input DIP switches are all in the "off" position.

BusMatrix™ Input Switch Setting

Each channel has a dedicated BusMatrix DIP switch that assigns that channel's source. To assign a signal from the Main Bus Input, select one of the first three switches which will give you either Left (L), Right (R) or Mono (L+R). To assign the channel's dedicated input select the fourth switch. Only ONE switch should be selected to the "ON" position.

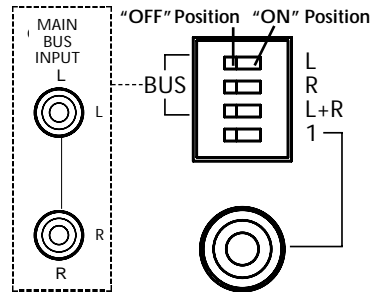

STEP	DESCRIPTION
1. Move only ONE switch to the "ON" position for each channel.	CAUTION! The DIP switch physically allows you to move all four of the switches to the "On" position. If you accidentally set more than one switch "On"; you will create an undesirable mix of inputs on the entire bus.

Setting the Turn-On Mode Switch

The SI-1230 has three turn-on modes. Select the mode you want by sliding the mode switch. See Installation Considerations on page 13 for more information about each of the turn-on modes.

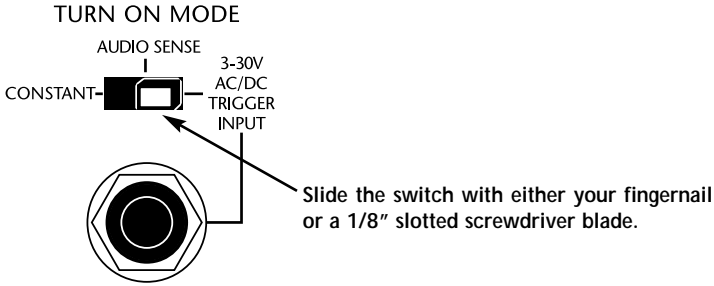

The Control Output

This terminal provides a 12V DC signal suitable for triggering Niles automated switchers, some motorized screens, some electric curtain controls, etc. This voltage is present only when the amplifier is active or on. When the amplifier turns off, the 12V signal is off.

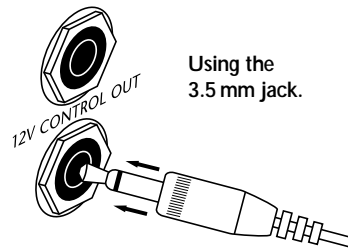

STEP	DESCRIPTION
<p>1. Check the requirements of the device you want to control.</p>	<p>The control output has a maximum current capability of 150 mA.</p>
<p>2. Connect the 3.5mm Jack to the control output maintaining proper polarity (tip = +)</p>	<p>Niles makes an accessory cable plug FG00724.</p>

Speaker Wire Connections

CAUTION! All speaker wire connections must be made with the amplifier Off.

Bare Wire

Unscrew the red or black plastic knob, insert the bare wire end into the opening, and then tighten the knob until the wire is securely clamped.

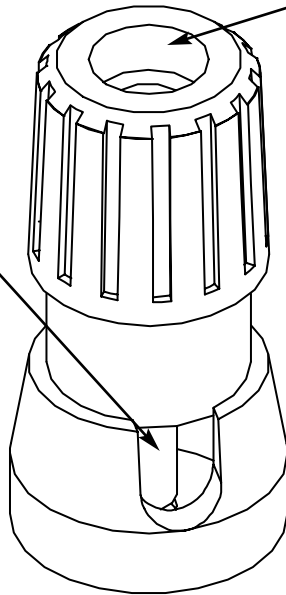

Banana Plugs

There are many types of banana plugs, some crimp, some solder. The Niles gold banana plug has a quick-connect binding post for the bare wire on the body of the plug. A banana plug is simply inserted into the jack at the end of the amplifier's binding post. Dual banana plugs will fit the SI-1230 binding posts.

STEP	
<p>1. Label all wires.</p>	<p>If you label the wires for their destination, rather than which terminal of the SI-1230 they are connected to, it will be easier to reconfigure your system in the future.</p>
<p>2. Connect one stripped wire end or banana plug to the black terminal and one to the red terminal.</p> <p>CAUTION- Avoid even a single strand of wire touching the chassis or another connector.</p>	<p>A. Split the speaker wire insulation so that at least two inches of each conductor are separated.</p> <p>B. Strip one half inch of insulation from the end of each conductor of the speaker wire</p> <p>C. Attach banana plugs or twist the strands of wire together and insert them into the appropriate binding post.</p>

Line Level Audio Inputs

CAUTION! THE AMPLIFIER MUST BE OFF WHENEVER YOU MAKE CHANGES TO THE INPUT CONNECTIONS.

STEP	DESCRIPTION
<p>1. Label all of the interconnecting cables for the sources they connect to.</p>	<p>Use audio patch cables with RCA phono plugs attached to the ends.</p>
<p>2. Connect the sources by inserting the RCA plug into the amplifier's jacks.</p> <p>NOTE: If you are using two amplifier channels in "bridged" mode connect the input cable to the even numbered amplifier input jack.</p>	<p>Connect outputs from your sources to inputs on the amplifier. Never connect a source or preamplifier's input (e.g., record inputs) to the inputs of your SI-1230.</p>

Cascade Audio Outputs

The "Cascade Audio Outputs" enable you to connect another amplifier to your preamplifier output. The connectors are gold-plated RCA phono jacks. Connect them to another amplifier's inputs with a standard audio patch cable. The outputs are not buffered; if you wish to daisy-chain more than 5 Niles amplifiers you will need a Niles ADA-6 buffered distribution amplifier. A single ADA-6 will allow you to daisy-chain 5 amplifiers from each of its six outputs, allowing 30 SI-1230 power amplifiers to be fed from the same master preamplifier. If your preamp has a vacuum tube output stage, you must use a Niles ADA-6 to drive more than a single SI-1230.

AC Power Plug

STEP	DESCRIPTION
Plug the attached 2 prong plug into a correctly grounded 120V 60 Hz wall outlet.	If you use a grounded power strip, surge suppressor or extension cord, verify that proper ground is maintained.
CAUTION! Do not plug the amplifier's cord into a preamplifier's convenience outlets.	The SI-1230 draws a maximum of approximately 890 watts from an AC wall outlet. This is much more than the typical accessory outlet on the back of a component will provide. Use the SI-1230's auto turn-on circuitry to turn on the SI-1230 whenever the preamp is on.

OPERATION

Power LED

The power LED indicates that the AC cord is plugged into a working AC power receptacle and that the power switch is in the "On" position.

Active LED

The rear panel turn-on mode switch determines when and how the amplifier will turn on. The "Active" LED indicates that the amplifier is on.

Power Switch

The front panel switch is a master or "vacation" power switch. No matter which turn-on mode you have selected, the master power switch will turn off all circuitry—including the sensing circuitry. If you are going on vacation and/or would like to reduce power consumption while you are away, turn the master power switch "Off" (push the rocker switch out). When you would like to return to normal operation, turn the switch "On" (push the rocker switch in).

D.C. Protection

In the event a damaging D.C. signal becomes present on any of the speaker terminals, the D.C. protection circuit shuts down the entire amplifier and the red LED labeled "Protection" illuminates. To reset the amplifier you must turn the front panel power switch "Off" and then "On."

Listening at Higher Volumes

Thirty watts is enough power to play a conventional speaker in a normal sized room loudly enough to completely drown out conversation. Even at levels like that, the SI-1230 will sound clear and clean. However, it requires more power to achieve a reasonable volume of sound in a large room than it does in a small room. It is possible (even if you are not a teenager) to turn the volume so high that the amplifier runs out of power. This creates "clipping" distortion.

Clipping distortion makes treble sound very harsh and unmusical. When you hear harsh sounding treble from any good speaker, turn the volume down immediately! Those harsh sounds are masking some much more powerful high frequency sound spikes which will quickly damage the tweeter of any loudspeaker.

If you continue to operate the amplifier at "clipping" power levels the protection circuits will operate when the amplifier overheats. The protection circuits reset when the amplifier's internal circuitry cools. Reduce the volume to prevent a reoccurrence. Perpetually overdriving your speakers and amplifier is abuse and probably voids the manufacturer's warranty of all affected products.

Cleaning and Maintenance

The internal parts of the SI-1230 are electronic and require no maintenance. Once a year it is appropriate to twist the RCA connectors on each input to remove any oxidation and improve conductivity.

You can clean the amplifier with soft cloth or paper towel dampened with water or a glass cleaner. Do not use any spray-type, abrasive cleaners on the amplifier.

TROUBLESHOOTING GUIDE

When there is a problem consult this guide first. If the problem persists, or you have additional questions, call your local Niles dealer or call Niles Technical Support at 1-800-289-4434. The most common problems relate to hook up.

SYMPTOM	POSSIBLE CAUSES AND TEST PROCEDURE
No sound on one channel	<p>BusMatrix DIP switch is not in the correct position. Check your configuration worksheet for the correct setting and verify.</p> <p>Short circuit or loose wire at speaker or amplifier terminals. Check that connections are secure and that there are no loose strands of wire crossing from the positive to the negative terminal at the back of the amplifier and the speaker.</p> <p>Short circuit or a break in the speaker wire. Disconnect the speaker wire at both ends, separate the 2 conductors at both ends and test with a meter for a short circuit. If there is no short, connect the two conductors at one end and test with a meter for continuity.</p> <p>Speaker is not working. Connect the speaker to a channel that plays another speaker.</p> <p>Audio cable to dedicated input is bad. Connect the non-working channel input to another cable that is known to be good.</p> <p>Bridging Switch is in the wrong position. Check your configuration worksheet for the correct setting and verify.</p> <p>The thermal protection circuit has operated because of overheating caused by overdriving or inadequate ventilation.</p>
No sound on some or all channels	<p>BusMatrix DIP switches are not in the correct positions. Check your configuration worksheet and verify all settings.</p> <p>Audio cable to the main bus inputs is bad. Connect the non-working channel input to another cable that is known to be good.</p> <p>Some or all of the internal amplifier fuses are blown. (Return the amplifier to your dealer for service).</p>

Have your configuration worksheet handy when you call.

TROUBLESHOOTING GUIDE (continued)

SYMPTOM	POSSIBLE CAUSES AND TEST PROCEDURE
Hum from all of the speakers	<p>Hum may be caused by a ground loop between two components in the system. To test for a ground loop, try reversing the AC plugs of each of the components in the system, that have non polarized plugs.</p> <p>Check for faulty cables, faulty source material, an ungrounded phono system, cable TV feed or a defective component.</p>
Amp will not turn on	<p>Master power switch must be on.</p> <p>AC power cord must be plugged into a working outlet.</p> <p>Test that the AC power receptacle is working. If the outlet tests O.K., the internal fuses are blown. Return the amplifier to your dealer for service.</p>
Sound is distorted on one or all of the channels at normal volumes	<p>BusMatrix DIP switches are not in the correct positions. Check your configuration worksheet and verify all settings.</p>
Normal volume cannot be reached	<p>One of the internal amplifier fuses is blown. (Return the amplifier to your dealer for service).</p>
Bass sound is weak and the stereo image is "phasey" sounding in one room	<p>Check that the bridging switch is "Off". If two adjacent channels are connected normally but the bridging switch is set to the "Bridged" position, the two speakers will play out of phase with each other.</p> <p>The loudspeakers are wired out of phase. Reverse the connections at the back of one speaker.</p>
A speaker connected to a bridged pair of amplifier channels sounds weak	<p>Check that the bridging switch is "On".</p>

CONFIGURATION WORKSHEET

BUS INS & OUTS		CONNECTED TO		
Left Main Bus				
Right Main Bus				
Cascade Output				
CH #	BRIDGED	DIP	INPUT SOURCE	SPEAKER
1	<input type="checkbox"/>			
2	<input type="checkbox"/>			
3	<input type="checkbox"/>			
4	<input type="checkbox"/>			
5	<input type="checkbox"/>			
6	<input type="checkbox"/>			
7	<input type="checkbox"/>			
8	<input type="checkbox"/>			
9	<input type="checkbox"/>			
10	<input type="checkbox"/>			
11	<input type="checkbox"/>			
12	<input type="checkbox"/>			
MODE SETTINGS		IN USE	SPECIAL CONNECTIONS OR NOTES	
Constant		<input type="checkbox"/>		
Audio Sense		<input type="checkbox"/>		
Voltage Trigger		<input type="checkbox"/>		
Control Output		<input type="checkbox"/>		

For ease of use, the Configuration Worksheet can be enlarged on a photocopier.

SPECIFICATIONS

Design Principle

Linear voltage/current amplification.

Continuous Power Output (FTC Rated)

(unbridged, all channels driven) 30 watts per channel RMS at 8 ohms and 37 watts per channel RMS at 4 ohms.

Bridged Power Output

(Two channels bridged, all channels driven)
80 watts per channel RMS at 8 ohms.

Input Impedance

10,000 ohms

Input Sensitivity

67mv for 1 watt out; 334mv for full output, (30 watts) level controls set at max.

Overall Voltage Gain

32.4 dB

Frequency Response

Bandwidth Limited from 5 Hz to 50 kHz

Distortion

(Bridged)

.06% THD 20 Hz-20 kHz All Channels Driven (8 Ω)

(Unbridged)

.04% THD 20 Hz-20 kHz All Channels Driven (8 Ω)

.06% THD 20 Hz-20 kHz All Channels Driven (4 Ω)

Overall Dimensions

17" wide x 5 1/2" high (including feet) x 15" deep

Weight

28 lbs



NILES®

Niles Audio
Corporation

12331 S.W. 130 Street
Miami, Florida 33186
Tel: (305) 238-4373
Fax: (305) 238-0185
www.nilesaudio.com

© 1999 Niles Audio Corporation. Because Niles strives to continuously improve its products, Niles reserves the right to change product specifications without notice. Niles, the Niles logo and Blending High Fidelity and Architecture are registered trademarks of Niles Audio Corporation. Systems Integration Amplifier and BusMatrix are trademarks of Niles Audio Corporation. Printed in the USA 11/97 DS00207B