



# NS-AP3700

## *HOME CINEMA SPEAKER PACKAGE*

### **CONTENTS**

CONSUMER PRECAUTIONS .....	2
UNPACKING .....	3
SETTING UP THE SPEAKERS .....	4
CONNECTIONS TO THE RECEIVER .....	6
SPEAKER PLACEMENT .....	7
SPECIFICATIONS .....	Back cover

**OWNER'S MANUAL**

## CONSUMER PRECAUTIONS

Read these precautions carefully before setting up your NS-AP3700 speakers.

- Since these speakers can be wall mounted, it is essential that they are firmly secured. Be sure to consult a reliable source about the best type of hanger for your particular wall's construction. Secure installation is the purchaser's responsibility.
- Do not attach them to thin plywood or soft wall surface materials as the screws may tear free, causing the speakers to fall and be damaged, or result in personal injury.
- Do not fasten the speakers to walls with nails, adhesives, or other unsafe hardware. Long-term use and vibrations may cause them to pull free.
- Do not place the speakers where they are liable to be knocked over or struck by falling objects. Stable placement will also ensure better sound performance.
- Placing the speakers on the same stand or shelf as a turntable can result in feedback.
- This speaker features a magnetically shielded design, but there is still a chance that placing it too close to a TV set might impair picture color. Should this happen, move the speaker away from the TV set.
- Never touch the woofer or tweeter units with your hands or expose them to excessive physical shock. If they are dented or bent, the sound will be distorted.
- Lower the power amplifier / receiver volume control before changing input sources. Never change input sources (for example, FM to CD) at high listening levels. Always turn the receiver / amplifier unit off when installing or removing input cables.
- Anytime you note distortion, reduce the volume control on your power amplifier / receiver to a lower setting. Never allow your power amplifier to be driven into "clipping".
- Do not attempt to clean the speakers with chemical solvents as this might damage the finish. To clean wipe with a dry, soft cloth.
- To prevent the enclosure from warping or discoloring, do not place the speakers where they will be exposed to direct sunlight or excessive humidity.
- To prevent the speakers from falling over, select a location which is flat and stable.
- To avoid accidents resulting from tripping over loose speaker cables and to prevent the speakers from falling, fix the speaker cables to the wall, etc.
- Secure placement or installation is the owner's responsibility.  
YAMAHA shall not be liable for any accident caused by improper placement or installation of speakers.

# UNPACKING

After unpacking, check that the following items are contained.

Center speaker x 1

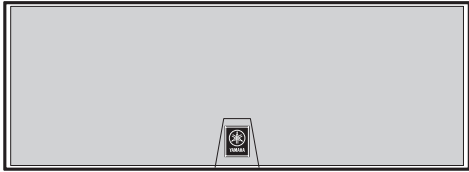

(NS-AP3700C)

Satellite speaker x 4



(NS-AP3700S)

Non-skid pads for Satellite speakers x 4

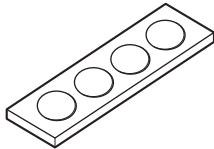

Fasteners for the center speaker x 2

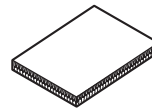

Speaker cable x 1

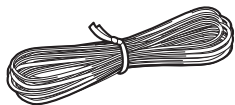

## SETTING UP THE SPEAKERS

### • Attaching the non-skid pads

Place the satellite speakers on a sturdy, vibration-free surface, such as a well-built stand. Attach the included non-skid pads to the bottom of the satellite speakers to prevent the speakers from slipping.

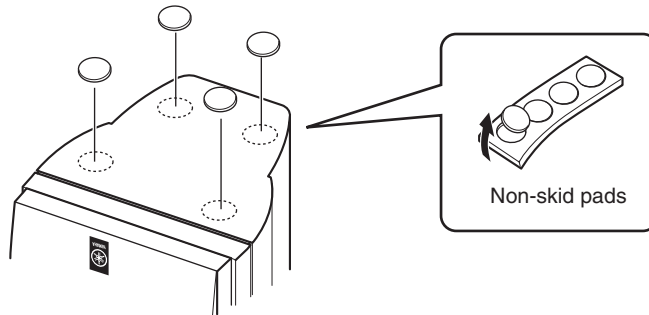

### • Wall mounting the satellite speakers

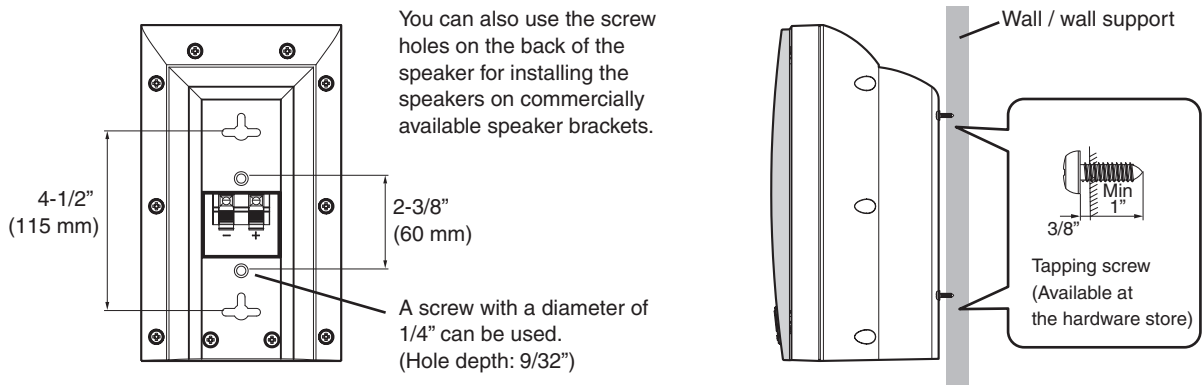

When using speaker brackets to mount the speakers on a wall or ceiling, it is strongly recommended that safety wire, which may be included with the bracket, be used between the speaker and the bracket to prevent the speaker from falling.

Fasten screws into a firm wall or wall support as shown in the figure, and hang the holes of the mounting bracket on the protruding screws.

Make sure that the screws are securely caught by the narrow sections of the "key hole" opening.

#### WARNING

- Each speaker weighs 1.74 lbs (0.79 kg). Do not mount the speakers on thin plywood or a wall with soft surface material, since the screws may pull away from the surface and fall. This will damage the speakers and can cause personal injury.
- Do not mount the speakers on a wall with nails, adhesives, or any other unstable hardware. Long-term use and vibrations may cause them to fall.
- To avoid accidents resulting from tripping over loose speaker cords, they should be affixed to the wall or floor molding.
- Secure installation is the purchaser's responsibility.

• **Positioning the center speaker**

Place the center speaker on top of the TV, on the floor in front of the TV, or inside the TV rack so that it is stable.

When placing the speaker on top of the TV, put the provided fasteners at four points on both the bottom of the speaker and on top of the TV to prevent the speaker from falling.

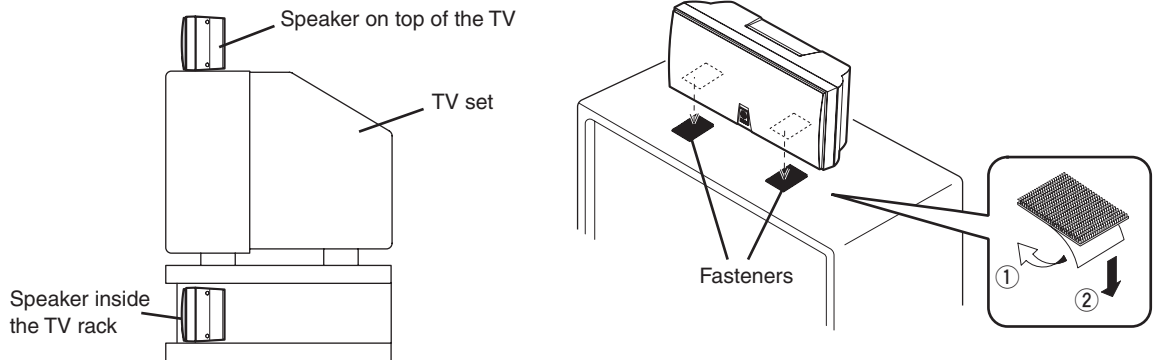

**Notes**

- Do not place the speaker on top of the TV if the area is smaller than the bottom area of the speaker. The speaker may fall and might cause personal injury.
- Though this speaker is a magnetically shielded type, there may be some influence on a TV picture depending on the type of TV or the placement of the speaker. In such a case, place the speaker apart from the TV so that there is no influence on the TV picture.

• **Wall mounting for the center speaker**

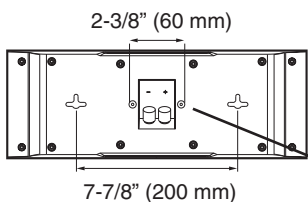

You can also use the screw holes on the back of the speaker for installing the speakers on commercially available speaker brackets.

A screw with a diameter of 1/4" can be used (Hole depth: 9/32")

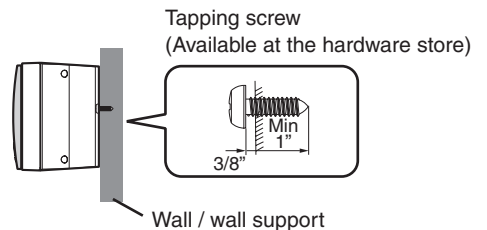

When using speaker brackets to mount the speakers on a wall or ceiling, it is strongly recommended that safety wire, which may be included with the bracket, be used between the speaker and the bracket to prevent the speaker from falling.

Fasten screws into a firm wall or wall support as shown in the figure, and hang the holes of the mounting bracket on the protruding screws.

Make sure that the screws are securely caught by the narrow sections of the "key hole" opening.

**WARNING**

- The center speaker weighs 3.18 lbs (1.44 kg). Do not mount the speaker on thin plywood or wall with soft surface material, since the screws may pull away from the surface and fall. This will damage the speaker and can cause personal injury.
- Do not install the speaker to a wall with nails, adhesives, or any other unstable hardware. Long-term use and vibrations may cause them to fall.
- To avoid accidents resulting from tripping over loose speaker cords, they should be affixed to the wall or floor molding.
- Secure installation is the purchaser's responsibility.

## CONNECTIONS TO THE RECEIVER

### CONNECTIONS

- Check to make sure that the power has been turned off before making connections.
- Connect the (+) terminal of the amplifier to the (+) terminal of the speaker.  
Connect the (-) terminal of the amplifier to the (-) terminal of the speaker.
- Reversing polarity (+/-) will result in unnatural sound reproduction.

### PROCEDURE

For connections, keep the speaker cords as short as possible. Do not bundle or roll up the excess part of the cords. If the connections are faulty, no sound will be heard from the speakers. Make sure that the + and - polarity markings of the speaker cords are observed and set correctly. If these cords are reversed, the sound will be unnatural and lack bass.

#### How to Connect:

##### • Center speaker

- ① Loosen the knob.
- ② Insert the bare wire. **Remove the insulation coating at the extremity of each speaker cable by twisting the coating off.**
- ③ Tighten the knob and secure the cable. Test the firmness of the connection by pulling lightly on the cable at the terminal.

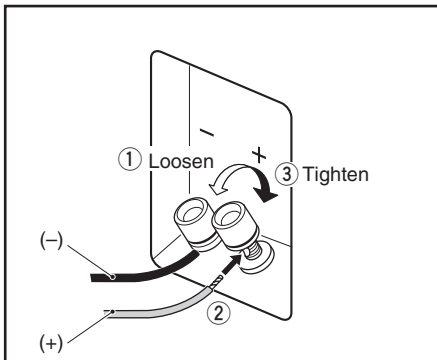

##### • When using a banana plug

- ① Remove the cover by pulling it toward you.
- ② Tighten the terminal knob.
- ③ Insert the banana plug into the terminal.

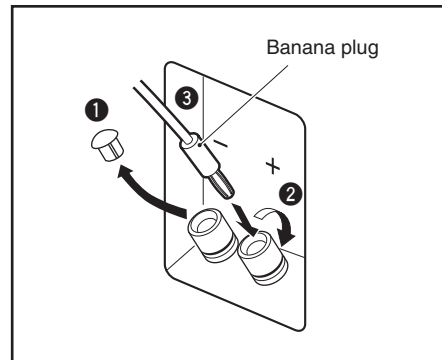

##### • Satellite speakers

- ① Press and hold the terminal's tab.
- ② Insert the bare wire into the terminal hole. **Remove the insulation coating at the extremity of each speaker cable by twisting the coating off.**
- ③ Release your finger from the tab to allow it to lock securely on the bare wire end.
- ④ Test the firmness of the connection by pulling lightly on the cord at the terminal.

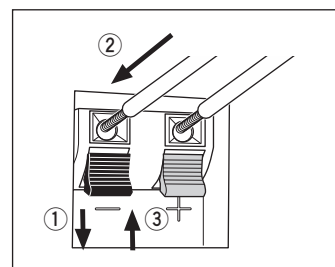

#### Note

- Do not let the bare speaker wires touch each other as this could damage the speaker, the amplifier, or both.

## SPEAKER PLACEMENT

This speaker system consists of front, center and surround speakers.

- **Front speaker** placement should be separated by a distance of 6–10ft. If they are placed too close together, there will be a reduction in the stereo effect. Conversely, if placed too far apart, the so called “middle-omission” effect will occur and the vocal center fill will be lost. Height of the speaker should be at least at ear level.
- **Center channel speaker** should be placed centered above or below the TV.
- **Surround speakers** should ideally be placed behind the listening area, at least as far apart as the front speakers and up to 2 additional feet apart per side. The height of the speaker should be at a minimum of ear level or preferably somewhat higher.

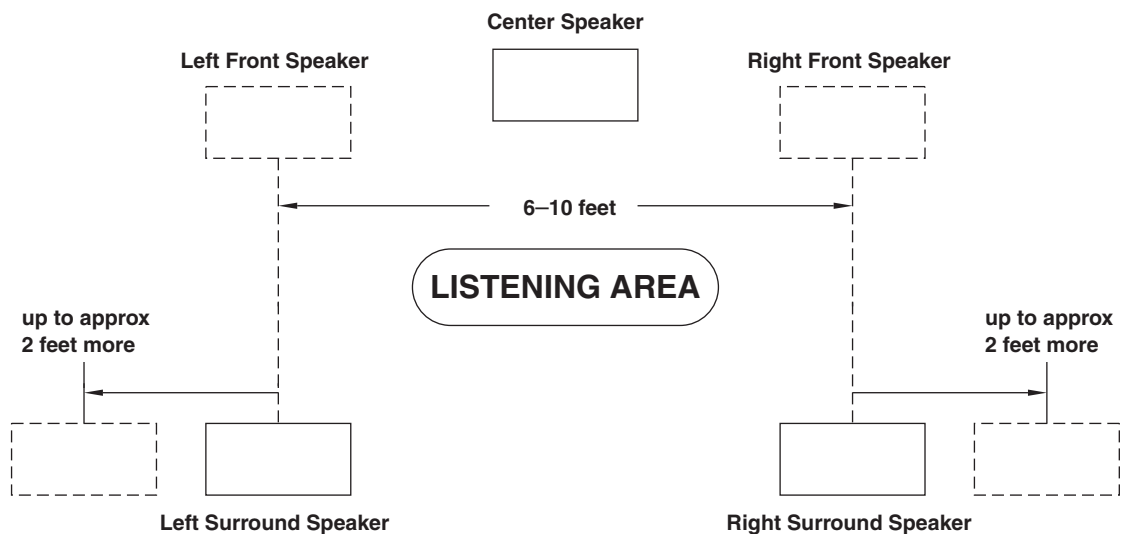

## SPECIFICATIONS

<b>Type</b>	1-Way Acoustic Suspension
<b>Speaker</b>	
Satellite	3" Paper Cone
Center	3" Paper Cone x 2
<b>Frequency Range</b>	
Satellite	90 Hz – 22,000 Hz
Center	90 Hz – 22,000 Hz
<b>Impedance</b>	6 ohms
<b>Nominal Input</b>	30 W
<b>Maximum Input</b>	100 W
<b>Sensitivity (dB/2.83v. 1m)</b>	
Satellite	82 dB
Center	83 dB
<b>Dimension (H x W x D)</b>	
Satellite	8-5/8" x 5-1/8" x 4-13/32" (219 x 130 x 112 mm)
Center	5-1/4" x 14-9/16" x 4-3/16" (133 x 370 x 106 mm)
<b>Weight</b>	
Satellite	1.74 lbs (0.79 kg)
Center	3.18 lbs (1.44 kg)
<b>Magnetic Shielding</b>	Yes

\*Specifications subject to change without notice due to product improvements.



YAMAHA ELECTRONICS CORPORATION, USA  
6660 ORANGETHORPE AVE.,  
BUENA PARK, CA 90620  
<http://www.yamaha.com/yec>  
Phone: 1-800-492-6242