





# *RX-397*

---

*Stereo Receiver*

OWNER'S MANUAL

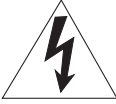
# IMPORTANT SAFETY INSTRUCTIONS

	<b>CAUTION</b> <b>RISK OF ELECTRIC SHOCK</b> <b>DO NOT OPEN</b>	
<b>CAUTION: TO REDUCE THE RISK OF ELECTRIC SHOCK, DO NOT REMOVE COVER (OR BACK). NO USER-SERVICEABLE PARTS INSIDE. REFER SERVICING TO QUALIFIED SERVICE PERSONNEL.</b>		

## • Explanation of Graphical Symbols



The lightning flash with arrowhead symbol, within an equilateral triangle, is intended to alert you to the presence of uninsulated “dangerous voltage” within the product’s enclosure that may be of sufficient magnitude to constitute a risk of electric shock to persons.



The exclamation point within an equilateral triangle is intended to alert you to the presence of important operating and maintenance (servicing) instructions in the literature accompanying the appliance.

### Note to CATV system installer:

This reminder is provided to call the CATV system installer’s attention to Article 820-40 of the NEC that provides guidelines for proper grounding and, in particular, specifies that the cable ground shall be connected to the grounding system of the building, as close to the point of cable entry as practical.

### IMPORTANT

Please record the serial number of this unit in the space below.

MODEL:

Serial No.:

The serial number is located on the rear of the unit.

Retain this Owner’s Manual in a safe place for future reference.

- 1 Read these instructions.
- 2 Keep these instructions.
- 3 Heed all warnings.
- 4 Follow all instructions.
- 5 Do not use this apparatus near water.
- 6 Clean only with dry cloth.
- 7 Do not block any ventilation openings. Install in accordance with the manufacturer’s instructions.
- 8 Do not install near any heat sources such as radiators, heat registers, stoves, or other apparatus (including amplifiers) that produce heat.
- 9 Do not defeat the safety purpose of the polarized or grounding-type plug. A polarized plug has two blades with one wider than the other. A grounding type plug has two blades and a third grounding prong. The wide blade or the third prong are provided for your safety. If the provided plug does not fit into your outlet, consult an electrician for replacement of the obsolete outlet.
- 10 Protect the power cord from being walked on or pinched particularly at plugs, convenience receptacles, and the point where they exit from the apparatus.
- 11 Only use attachments/accessories specified by the manufacturer.
- 12 Use only with the cart, stand, tripod, bracket, or table specified by the manufacturer, or sold with the apparatus. When a cart is used, use caution when moving the cart/apparatus combination to avoid injury from tip-over.
- 13 Unplug this apparatus during lightning storms or when unused for long periods of time.
- 14 Refer all servicing to qualified service personnel. Servicing is required when the apparatus has been damaged in any way, such as power-supply cord or plug is damaged, liquid has been spilled or objects have fallen into the apparatus, the apparatus has been exposed to rain or moisture, does not operate normally, or has been dropped.



## We Want You Listening For A Lifetime

YAMAHA and the Electronic Industries Association’s Consumer Electronics Group want you to get the most out of your equipment by playing it at a safe level. One that lets the sound come through loud and clear without annoying blaring or distortion – and, most importantly, without affecting your sensitive hearing. Since hearing damage from loud sounds is often undetectable until it is too late, YAMAHA and the Electronic Industries Association’s Consumer Electronics Group recommend you to avoid prolonged exposure from excessive volume levels.



## FCC INFORMATION (for US customers)

### 1 **IMPORTANT NOTICE: DO NOT MODIFY THIS UNIT!**

This product, when installed as indicated in the instructions contained in this manual, meets FCC requirements. Modifications not expressly approved by Yamaha may void your authority, granted by the FCC, to use the product.

### 2 **IMPORTANT:** When connecting this product to accessories and/or another product use only high quality shielded cables. Cable/s supplied with this product **MUST** be used. Follow all installation instructions. Failure to follow instructions could void your FCC authorization to use this product in the USA.

### 3 **NOTE:** This product has been tested and found to comply with the requirements listed in FCC Regulations, Part 15 for Class "B" digital devices. Compliance with these requirements provides a reasonable level of assurance that your use of this product in a residential environment will not result in harmful interference with other electronic devices.

This equipment generates/uses radio frequencies and, if not installed and used according to the instructions found in the users manual, may cause interference harmful to the operation of other electronic devices.

Compliance with FCC regulations does not guarantee that interference will not occur in all installations. If this product is found to be the source of interference, which can be determined by turning the unit "OFF" and "ON", please try to eliminate the problem by using one of the following measures:

Relocate either this product or the device that is being affected by the interference.

Utilize power outlets that are on different branch (circuit breaker or fuse) circuits or install AC line filter/s.

In the case of radio or TV interference, relocate/reorient the antenna. If the antenna lead-in is 300 ohm ribbon lead, change the lead-in to coaxial type cable.

If these corrective measures do not produce satisfactory results, please contact the local retailer authorized to distribute this type of product. If you can not locate the appropriate retailer, please contact Yamaha Electronics Corp., U.S.A. 6660 Orangethorpe Ave, Buena Park, CA 90620.

The above statements apply **ONLY** to those products distributed by Yamaha Corporation of America or its subsidiaries.

# CAUTION: READ THIS BEFORE OPERATING YOUR UNIT.

- 1 To assure the finest performance, please read this manual carefully. Keep it in a safe place for future reference.
- 2 Install this sound system in a well ventilated, cool, dry, clean place – away from direct sunlight, heat sources, vibration, dust, moisture, and/or cold. Allow ventilation space of at least 30 cm on the top, 20 cm on the left and right, and 20 cm on the back of this unit.
- 3 Locate this unit away from other electrical appliances, motors, or transformers to avoid humming sounds.
- 4 Do not expose this unit to sudden temperature changes from cold to hot, and do not locate this unit in an environment with high humidity (i.e. a room with a humidifier) to prevent condensation inside this unit, which may cause an electrical shock, fire, damage to this unit, and/or personal injury.
- 5 Avoid installing this unit where foreign objects may fall onto this unit and/or this unit may be exposed to liquid dripping or splashing. On the top of this unit, do not place:
  - Other components, as they may cause damage and/or discoloration on the surface of this unit.
  - Burning objects (i.e. candles), as they may cause fire, damage to this unit, and/or personal injury.
  - Containers with liquid in them, as they may fall and liquid may cause electrical shock to the user and/or damage to this unit.
- 6 Do not cover this unit with a newspaper, tablecloth, curtain, etc. in order not to obstruct heat radiation. If the temperature inside this unit rises, it may cause fire, damage to this unit, and/or personal injury.
- 7 Do not plug in this unit to a wall outlet until all connections are complete.
- 8 Do not operate this unit upside-down. It may overheat, possibly causing damage.
- 9 Do not use force on switches, knobs and/or cords.
- 10 When disconnecting the power cable from the wall outlet, grasp the plug; do not pull the cable.
- 11 Do not clean this unit with chemical solvents; this might damage the finish. Use a clean, dry cloth.
- 12 Only voltage specified on this unit must be used. Using this unit with a higher voltage than specified is dangerous and may cause fire, damage to this unit, and/or personal injury. YAMAHA will not be held responsible for any damage resulting from use of this unit with a voltage other than specified.
- 13 To prevent damage by lightning, keep the power cord and outdoor antennas disconnected from a wall outlet or the unit during a lightning storm.
- 14 Do not attempt to modify or fix this unit. Contact qualified YAMAHA service personnel when any service is needed. The cabinet should never be opened for any reasons.
- 15 When not planning to use this unit for long periods of time (i.e. vacation), disconnect the AC power plug from the wall outlet.
- 16 Install this unit near the AC outlet and where the AC power plug can be reached easily.
- 17 Be sure to read the “TROUBLESHOOTING” section on common operating errors before concluding that this unit is faulty.
- 18 Before moving this unit, press STANDBY/ON to set this unit to the standby mode, and disconnect the AC power plug from the wall outlet.
- 19 **VOLTAGE SELECTOR** (Asia and General models only)  
The VOLTAGE SELECTOR on the rear panel of this unit must be set for your local main voltage BEFORE plugging into the AC main supply. Voltages are:  
General model .....AC 110/120/220/230–240 V, 50/60 Hz  
Asia model .....AC 220/230–240 V, 50/60 Hz

## WARNING

TO REDUCE THE RISK OF FIRE OR ELECTRIC SHOCK, DO NOT EXPOSE THIS UNIT TO RAIN OR MOISTURE.

This unit is not disconnected from the AC power source as long as it is connected to the wall outlet, even if this unit itself is turned off by STANDBY/ON. This state is called the standby mode. In this state, this unit is designed to consume a very small quantity of power.

## FOR CANADIAN CUSTOMERS

To prevent electric shock, match wide blade of plug to wide slot and fully insert.  
This Class B digital apparatus complies with Canadian ICES-003.

## POUR LES CONSOMMATEURS CANADIENS

Pour éviter les chocs électriques, introduire la lame la plus large de la fiche dans la borne correspondante de la prise et pousser jusqu'au fond.  
Cet appareil numérique de la classe B est conforme à la norme NMB-003 du Canada.

# CONTENTS

## INTRODUCTION

<b>FEATURES</b> .....	2
<b>SUPPLIED ACCESSORIES</b> .....	2
<b>CONTROLS AND FUNCTIONS</b> .....	3
Front panel.....	3
Front panel display .....	5
Rear panel .....	6
Remote control.....	7
Installing batteries in the remote control .....	8
Using the remote control .....	8

## PREPARATION

<b>CONNECTIONS</b> .....	9
Connecting speakers .....	10
Connecting the AM and FM antennas .....	11
Connecting the power supply cord .....	13
Turning on and off this unit .....	14

## OPERATION

<b>PLAYING AND RECORDING</b> .....	15
Playing a source .....	15
Adjusting the tonal quality.....	16
Recording a source .....	17
Using the SLEEP timer.....	18
Muting the sound output.....	19
<b>FM/AM TUNING</b> .....	20
Automatic tuning .....	20
Manual tuning.....	21
Automatic preset tuning.....	21
Manual preset tuning .....	23
Selecting preset stations.....	24
Exchanging preset stations .....	24
<b>ADVANCED SETUP</b> .....	25
Changing the ADVANCED SETUP menu parameters.....	25

## ADDITIONAL INFORMATION

<b>TROUBLESHOOTING</b> .....	27
<b>SPECIFICATIONS</b> .....	30

INTRODUCTION

PREPARATION

OPERATION

ADDITIONAL  
INFORMATION

# FEATURES

## Built-in 2-channel power amplifier

- ◆ Minimum RMS output power  
50 W + 50 W (8 Ω), 0.04% THD, 20 Hz to 20 kHz
- ◆ Highly dynamic power, low impedance drive capability

## Sophisticated AM/FM tuner

- ◆ 40-station random access preset tuning
- ◆ Automatic preset tuning
- ◆ Preset station exchanging capability
- ◆ Radio Data System tuning capability (Europe model only)

## Other features

- ◆ PURE DIRECT button used to reproduce the purest source sound
- ◆ Continuously variable loudness control
- ◆ Sleep timer
- ◆ Remote control capability

-  indicates a tip for your operation.
- Some operations can be performed by using either the buttons on the front panel of this unit or those on the remote control. In case the button names differ between this unit and the remote control, the names of the buttons on the remote control are given in parentheses.
- This manual is printed prior to production. Design and specifications are subject to change in part as a result of improvements, etc. In case of differences between the manual and the product, the product has priority.

# SUPPLIED ACCESSORIES

Please check that you received all of the following parts.

Remote control

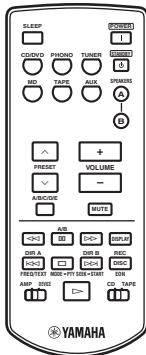

Batteries (x2)  
(AAA, R03, UM-4)

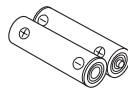

AM loop antenna



Indoor FM antenna  
(U.S.A., Canada and  
General models)

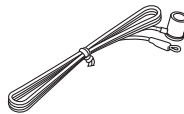

Indoor FM antenna  
(Europe and Australia  
models)

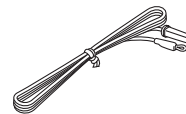

# CONTROLS AND FUNCTIONS

## Front panel

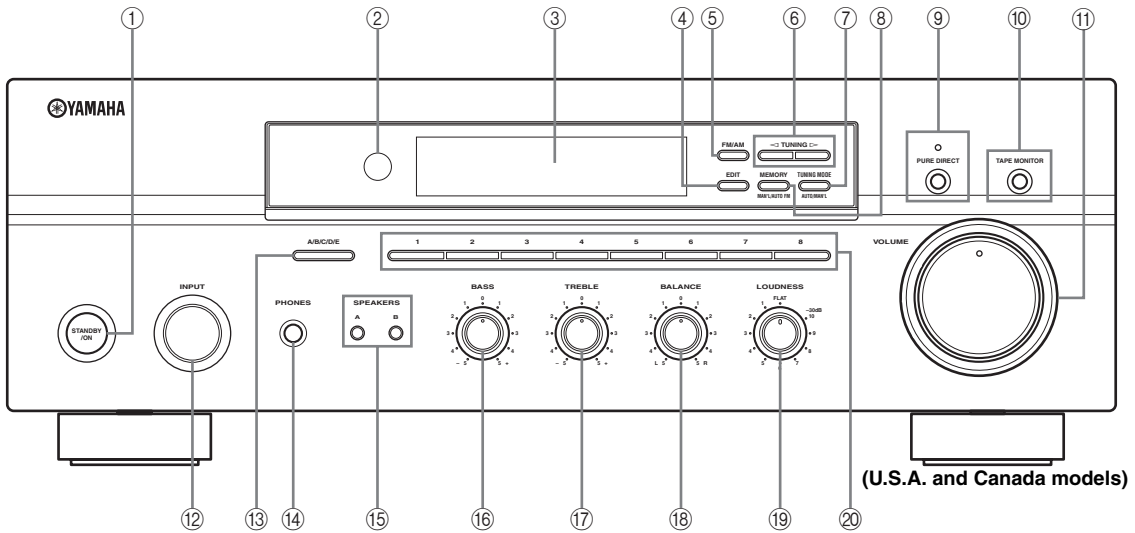

(U.S.A. and Canada models)

### ① **STANDBY/ON**

Turns on this unit or sets it to the standby mode. See page 14 for details.

#### **Note**

In the standby mode, this unit consumes a small amount of power to receive infrared signals from the remote control.

### ② **Remote control sensor**

Receives infrared signals from the remote control.

### ③ **Front panel display**

Shows information about the operational status of this unit.

### ④ **EDIT**

Exchanges the assignment of two preset stations with each other when TUNER is selected as the input source (see page 24).

### ⑤ **FM/AM**

Switches the reception band between AM and FM when TUNER is selected as the input source (see page 20).

### ⑥ **TUNING** ◀ / ▶

Selects the tuning frequency when TUNER is selected as the input source (see page 20).

### ⑦ **TUNING MODE**

Switches the tuning mode between automatic (the AUTO indicator turns on as a result) and manual (the AUTO indicator turns off as a result) when TUNER is selected as the input source.

### ⑧ **MEMORY**

Stores a station in the system memory (see page 23). Sets this unit to the automatic preset tuning mode (see page 21).

### ⑨ **PURE DIRECT and indicator**

Allows you to listen to a source in the purest possible sound. The indicator above it lights up when this function is turned on (see page 16).

### ⑩ **TAPE MONITOR**

Allows you to listen to the sound played back on the tape deck connected to the TAPE terminals on the rear panel of this unit.

When the 3-head tape deck is used for recording, you can also monitor the sound being recorded.

The TAPE MON indicator lights up in the front panel display when you press TAPE MONITOR (see page 17).

#### **Notes**

- When TAPE MON indicator lights up, you cannot select any input source.
- To listen to the source selected with the INPUT selector, press TAPE MONITOR again so that the TAPE MON indicator turns off.
- When TAPE (tape deck) is selected with the INPUT selector, this function will not turn on even if TAPE MONITOR is pressed.

**⑪ VOLUME**

Increases or decreases the sound output level.

**Note**

This does not affect the OUT (REC) level.

**⑫ INPUT selector**

Selects the input source you want to listen to.

**⑬ A/B/C/D/E**

Selects the preset station group (A to E) when TUNER is selected as the input source (see page 22).

**⑭ PHONES jack**

Outputs audio for private listening with your headphones.

**Note**

Press SPEAKERS A and B so that the SP A/B indicators turn off before you connect your headphones to the PHONES jack.

**⑮ SPEAKERS A/B**

Turns on or off the speaker set connected to the SPEAKERS A and/or SPEAKERS B terminals on the rear panel each time the corresponding button is pressed (see page 15).

**⑯ BASS**

Increases or decreases the low frequency response. The 0 position produces a flat response (see page 16).

**⑰ TREBLE**

Increases or decreases the high frequency response. The 0 position produces a flat response (see page 16).

**⑱ BALANCE**

Adjusts the sound output balance of the left and right speakers to compensate for sound imbalances caused by speaker locations or listening room conditions (see page 16).

**⑲ LOUDNESS**

Retains a full tonal range at any volume level to compensate for the human ears' loss of sensitivity to high and low-frequency ranges at a low volume level (see page 16).

**⑳ Preset station number buttons  
(1 to 8)**

Selects the preset station number (1 to 8) directly when TUNER is selected as the input source (see page 24).



## Front panel display

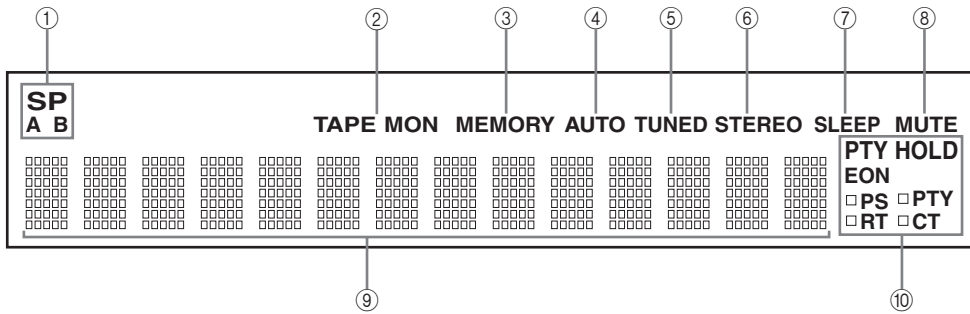

### ① SP (SPEAKERS) A/B indicators

Light up according to the set of speakers selected. Both indicators light up when both sets of speakers are selected.

### ② TAPE MON (MONITOR) indicator

Lights up while the TAPE monitor function is turned on.

### ③ MEMORY indicator

Flashes for approximately 5 seconds after MEMORY on the front panel is pressed. While the MEMORY indicator is flashing, store the displayed station in the system memory by using A/B/C/D/E and one of the preset station number buttons on the front panel.

### ④ AUTO indicator

Lights up when this unit is in the automatic tuning mode.

### ⑤ TUNED indicator

Lights up when this unit is tuned into a station.

### ⑥ STEREO indicator

Lights up when this unit is receiving a strong signal for an FM stereo broadcast while the AUTO indicator is lit.

### ⑦ SLEEP indicator

Lights up when the sleep timer is turned on.

### ⑧ MUTE indicator

Flashes while the MUTE function is turned on.

### ⑨ Multi-information display

Shows information when adjusting or changing settings.

### ■ Europe model only

### ⑩ Radio Data System indicators

The box-shaped indicator beside the name of each Radio Data System mode lights up when the corresponding Radio Data System mode is selected.

#### PTY HOLD indicator

Lights up while searching for stations in the PTY SEEK mode.

#### EON indicator

Lights up when the Radio Data System station that offers the EON data service is being received.

## Rear panel

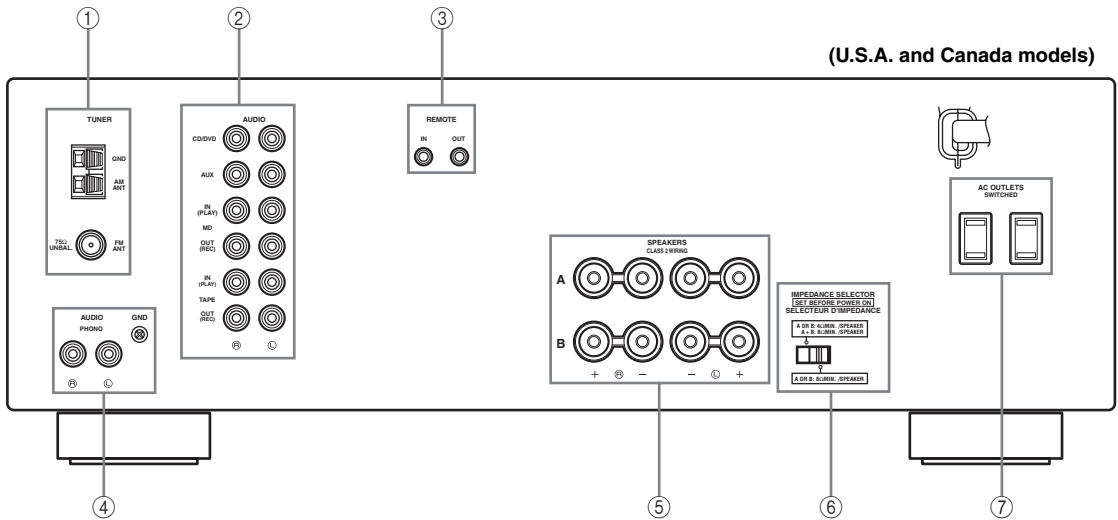

**① Antenna terminals**

Connect FM and AM antennas.  
See page 11 for connections information.

**② AUDIO jacks**

Connect audio components.  
See page 9 for connection information.

**③ REMOTE jacks**

These jacks are used to input/output remote control signals.  
See page 13 for connection information.

**④ PHONO jacks and GND terminal**

Connect a turntable.  
See page 9 for connection information.

**⑤ SPEAKERS terminals**

Connect speakers.  
See page 10 for connection information.

**⑥ IMPEDANCE SELECTOR switch**

Switches the impedance setting.  
See page 13 for details.

**⑦ AC OUTLET(S) (SWITCHED)**

Use to supply power to your other audio components.  
See page 13 for details.

**■ Asia and General models only**

**VOLTAGE SELECTOR**

See page 13 for details.

## Remote control

This section describes the function of each button on the remote control used to control this unit or other components made by YAMAHA. The functions of the buttons used to control your other audio components are the same as those of the corresponding buttons on those components. Refer to those components' instruction manuals for details.

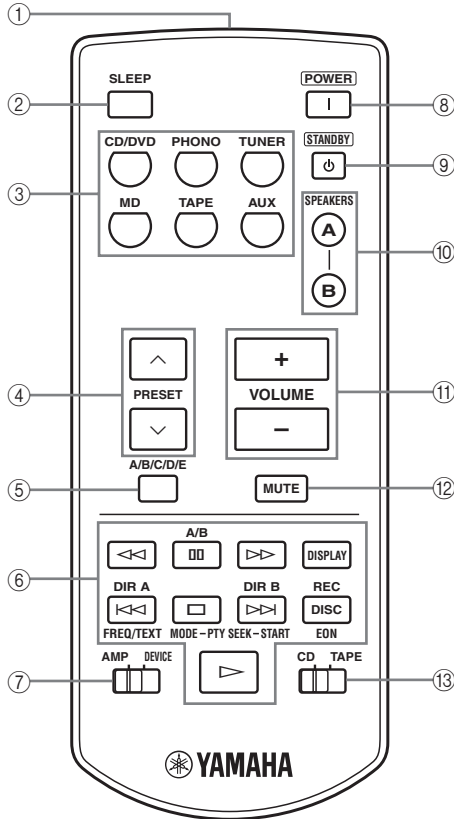

### ① Infrared signal transmitter

Sends infrared signals.

### ② SLEEP

Sets the sleep timer.

### ③ Input selector buttons

Select the desired input source.

### ④ PRESET $\wedge$ / $\vee$

Selects the preset station number (1 to 8) when TUNER is selected as the input source.

### ⑤ A/B/C/D/E

Selects the preset station group (A to E) when TUNER is selected as the input source.

### ⑥ Radio Data System/CD player/Cassette tape deck control buttons

Controls Radio Data System features, YAMAHA CD players or YAMAHA cassette tape deck.

#### Note

The Radio Data System features (FREQ/TEXT, PTY SEEK MODE and PTY SEEK START) are only applicable to the Europe model and are operational only when TUNER is selected as the input source and the AMP/DEVICE switch is slid to the AMP position.

### ⑦ AMP/DEVICE switch

Switches the function of the control buttons numbered ⑥ between controlling this unit and controlling YAMAHA CD players or YAMAHA cassette tape deck.

### ⑧ POWER

Turns on this unit.

### ⑨ STANDBY

Sets this unit to the standby mode.

#### Note

In the standby mode, this unit consumes a small amount of power to receive infrared signals from the remote control.

### ⑩ SPEAKERS A/B

Turns on or off the set of speakers connected to the SPEAKERS A and/or SPEAKERS B terminals on the rear panel of this unit when the corresponding button is pressed each time.

### ⑪ VOLUME +/−

Increases or decreases the sound output level.

#### Notes

- This does not affect the OUT (REC) level.
- When you press VOLUME +/− to control the sound output level of this unit, VOLUME on the front panel rotates.

### ⑫ MUTE

Mutes the sound output. Press again to restore the sound output to the previous volume level (see page 19).

### ⑬ CD/TAPE switch

Switches the function of the control buttons numbered ⑥ between controlling YAMAHA CD players and controlling YAMAHA cassette tape deck when the AMP/DEVICE switch is slid to the DEVICE position.

## Installing batteries in the remote control

### ■ Notes on batteries

- Change all of the batteries if the operation range of the remote control decreases.
- Use AAA, R03, UM-4 batteries for the remote control.
- Make sure that the polarities are correct. See the illustration inside the battery compartment of each remote control.
- Remove the batteries if the remote control is not used for an extended period of time.
- Do not use old batteries together with new ones.
- Do not use different types of batteries (such as alkaline and manganese batteries) together. Read the packaging carefully as these different types of batteries may have the same shape and color.
- We strongly recommend using alkaline batteries.
- If the batteries have leaked, dispose of them immediately. Avoid touching the leaked material or letting it come into contact with clothing, etc. Clean the battery compartment thoroughly before installing new batteries.
- Do not throw away batteries with general house waste; dispose of them correctly in accordance with your local regulations.

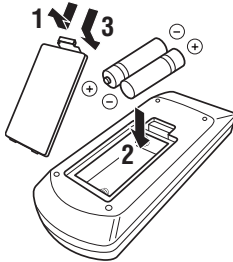

- 1 Open the battery compartment cover.**
- 2 Insert the supplied batteries in each remote control according to the polarity markings (+ and -) on the inside of the battery compartment.**
- 3 Close the cover back.**

## Using the remote control

The remote control transmit a directional infrared beam.

Be sure to aim the remote control directly at the remote control sensor on the front panel of this unit.

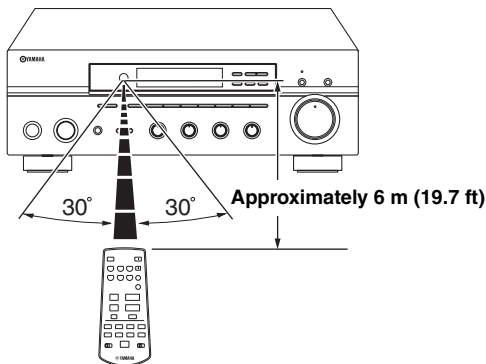

### ■ Handling the remote control

- The area between the remote control and this unit must be clear of large obstacles.
- Do not spill water or other liquids on the remote control.
- Do not drop the remote control.
- Do not leave or store the remote control in the following types of conditions:
  - places of high humidity, such as near a bath
  - places of high temperature, such as near a heater or a stove
  - places of extremely low temperatures
  - dusty places
- Do not expose the remote control sensor to strong lighting, in particular, an inverter type fluorescent lamp; otherwise, the remote control may not work properly. If necessary, position this unit away from direct lighting.

# CONNECTIONS

## CAUTION

- Do not connect this unit or other components to the main power until all connections between components are complete.
- Do not let the bare speaker wires touch each other or do not let them touch any metal part of this unit. This could damage this unit and/or the speakers.
- All connections must be correct: L (left) to L, R (right) to R, “+” to “+” and “-” to “-”. If the connections are faulty, no sound will be heard from the speakers, and if the polarity of the speaker connections is incorrect, the sound will be unnatural and lack bass. Also, refer to the owner’s manual for each of your components.
- Use the RCA type pin plug cables for audio components except speakers.

-  The PHONO jacks are designed to connect a turntable with an MM or high-output MC cartridge. If you have a turntable with a low-output MC cartridge, use an in-line boosting transformer or an MC-head amplifier when connecting your turntable to the PHONO jacks.
- Connect your turntable to the GND terminal to reduce noise in the signal. However, you may hear less noise without the connection to the GND terminal for some record players.

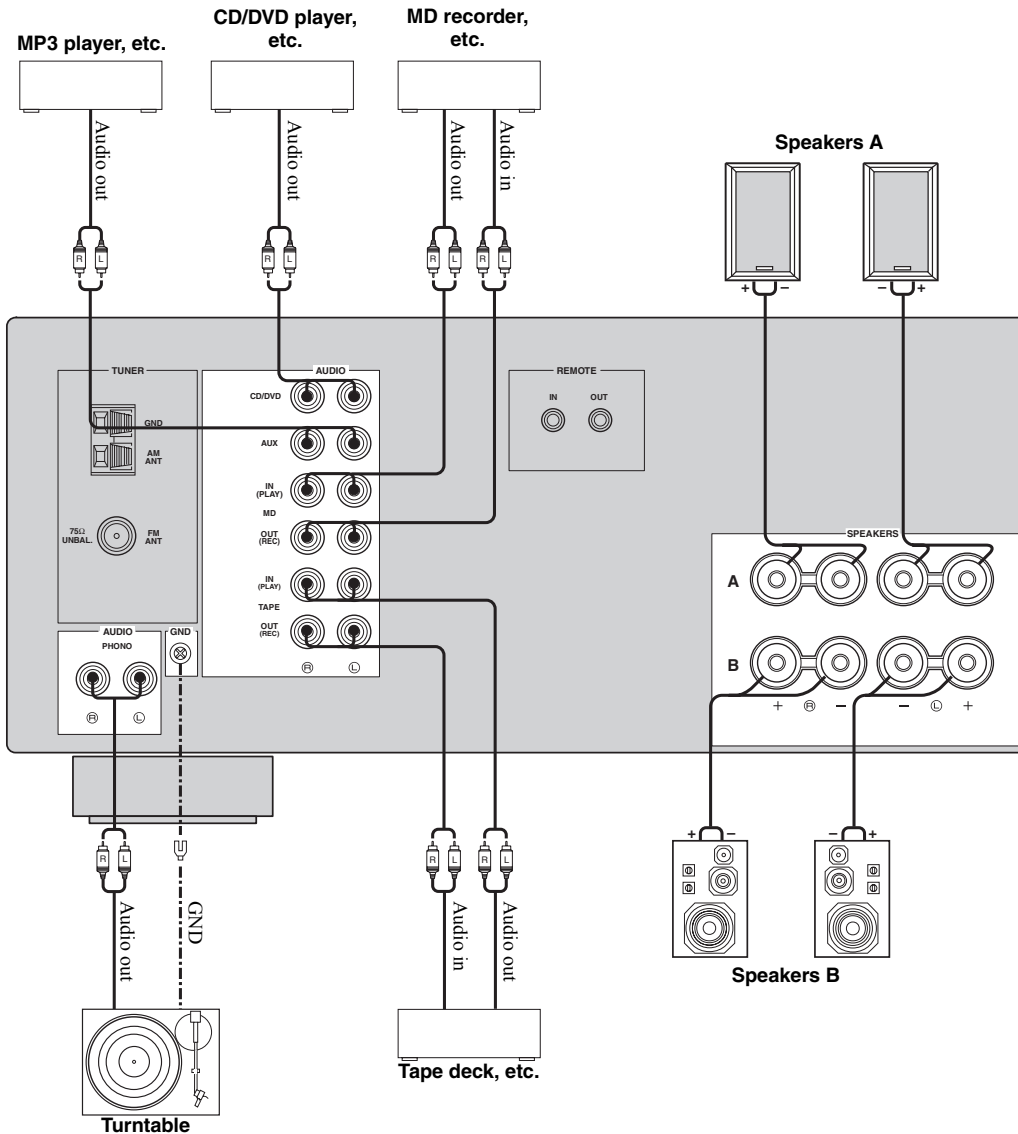

## Connecting speakers

Be sure to connect the left channel (L), right channel (R), “+” (red) and “-” (black) properly.

### CAUTION

Before connecting the speakers, make sure that the power of this unit is off.

- 1 Remove approximately 10 mm (3/8 in) of insulation from the end of each speaker cable and twist the exposed wires of the cable together to prevent short circuits.

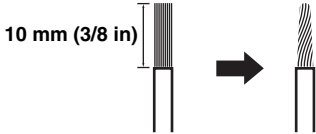

- 2 Unscrew the knob.

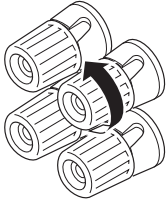

Red: positive (+)  
Black: negative (-)

- 3 Insert one bare wire into the hole in the side of each terminal.

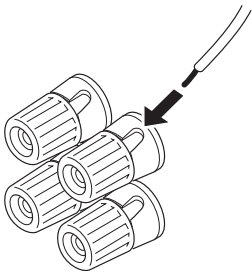

Red: positive (+)  
Black: negative (-)

- 4 Tighten the knob to secure the wire.

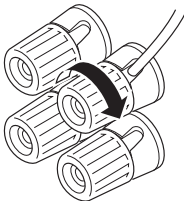

Red: positive (+)  
Black: negative (-)

### ■ Connecting the banana plug (U.S.A., Canada, Australia and General models only)

First, tighten the knob and then insert the banana plug into the end of the corresponding terminal.

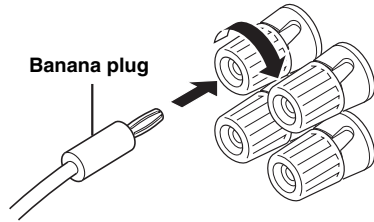

### Notes

- One or two speaker sets can be connected to this unit. If you use only one speaker set, connect it to either the SPEAKERS A or B terminals.
- Use speakers with the specified impedance shown on the rear panel of this unit.

## Connecting the AM and FM antennas

Both AM and FM indoor antennas are included with this unit. In general, these antennas should provide sufficient signal strength. Connect each antenna correctly to the designated terminals.

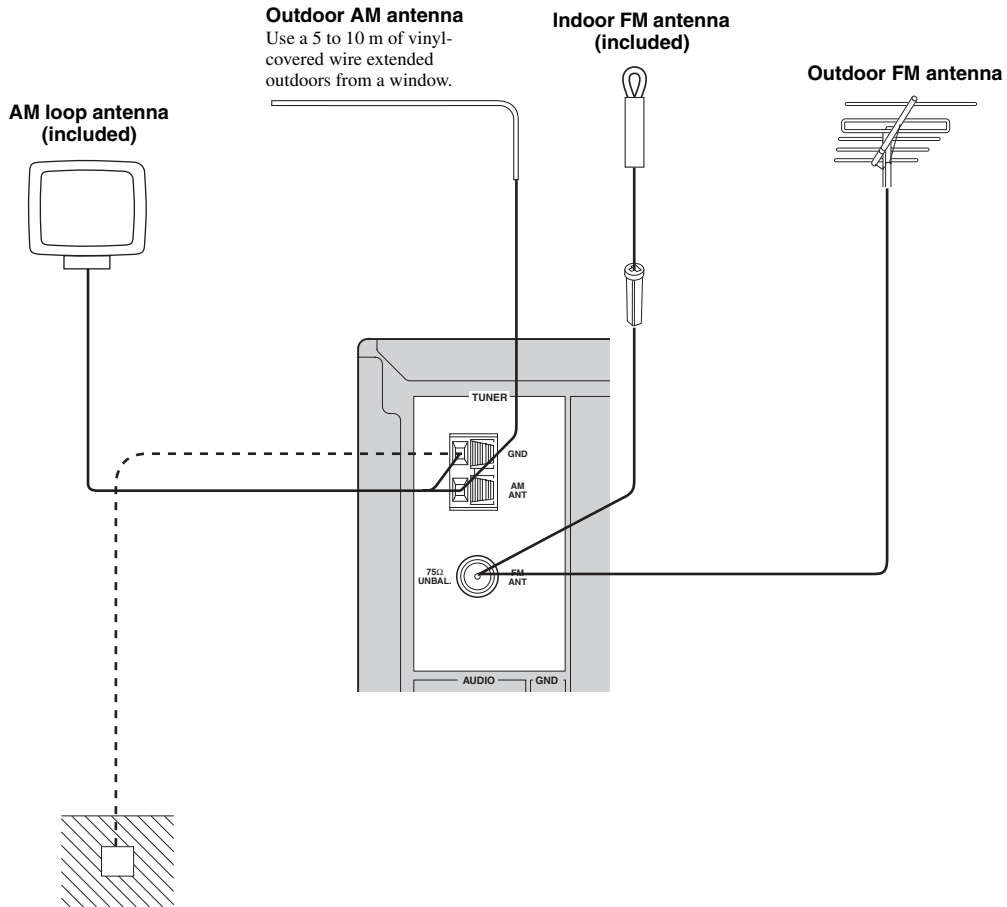

### Ground (GND terminal)

For maximum safety and minimum interference, connect the antenna GND terminal to a good earth ground. A good earth ground is a metal stake driven into moist earth.

### Notes

- A properly installed outdoor antenna provides clearer reception than an indoor one. If you experience poor reception quality, an outdoor antenna may improve the quality. Consult your nearest authorized YAMAHA dealer or service center about outdoor antennas.
- If you connect an outdoor FM antenna to this unit, do not connect the indoor FM antenna to this unit.
- To minimize interference from automobile ignition, locate the antenna as far from heavy traffic as possible.
- Keep the feeder cable or coaxial cable as short as possible. Do not bundle or roll up excess cable.
- The antenna should be placed at least 2 meters from reinforced concrete walls or metal structures.

■ **Connecting the AM loop antenna**

**1** Set up the AM loop antenna.

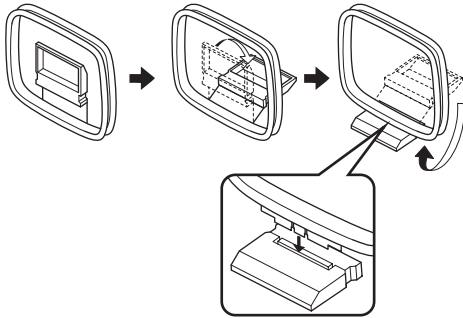

**2** Press and hold the tab.

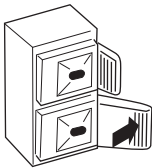

**3** Insert the AM loop antenna lead wires into the AM ANT terminal.

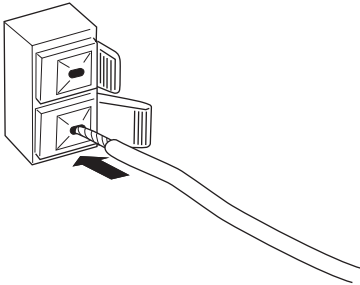

**4** Release the tab.

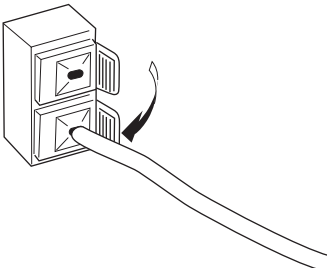

**5** Repeat steps 2 to 4 to insert the AM loop antenna lead wires into the GND terminal.

**6** Orient the AM loop antenna for the best reception.

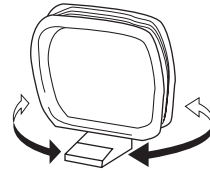

**Notes**

- The AM loop antenna should be placed away from this unit.
- A properly installed outdoor antenna provides clearer reception than an indoor one. If you experience poor reception quality, an outdoor antenna may improve the quality. It is recommended that you should connect a 5 to 10 m of vinyl-covered wire to the AM ANT terminal and extend it outdoors from a window. Consult your nearest authorized YAMAHA dealer or service center about outdoor antennas.
- The AM loop antenna should always be connected, even if an outdoor AM antenna is connected to this unit.



## Connecting the power supply cord

Plug the power supply cord into the AC wall outlet after all other connections are complete.

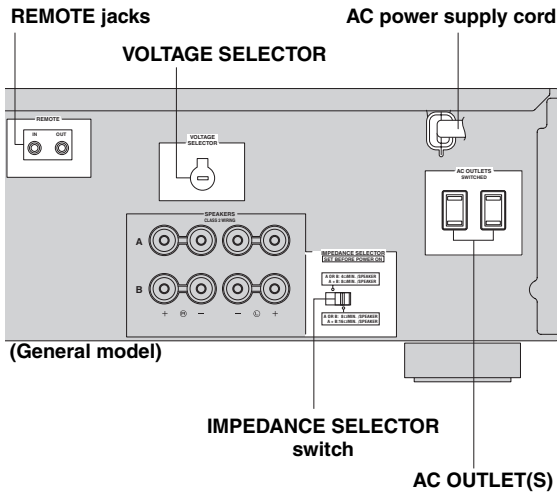

### Memory back-up

The memory back-up circuit prevents the stored data from being lost. However, the stored data will be lost if the power cord is disconnected from the AC wall outlet for more than one week.

### AC OUTLET(S) (SWITCHED)

Australia model ..... 1 outlet  
Other models ..... 2 outlets

Use these outlets to connect the power supply cords from your other components to this unit. The AC OUTLET(S) supplies power to any connected components whenever the power of this unit is turned on. For information on the maximum power (total power consumption of components), see “SPECIFICATIONS” on page 30.

### REMOTE jacks

Some YAMAHA models are able to connect directly to the REMOTE jack on the rear panel of this unit. If you own these products, you may not need to use an infrared emitter. Up to six YAMAHA components can be connected as shown below.

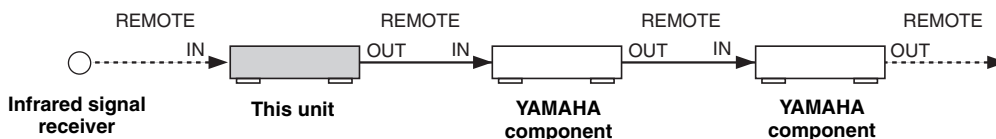

### VOLTAGE SELECTOR (Asia and General models only)

VOLTAGE SELECTOR on the rear panel of this unit must be set for your local main voltage BEFORE plugging the power supply cord into the AC wall outlet.

Voltages are as follows:

Asia model ..... AC 220/230–240 V, 50/60 Hz  
General model ..... AC 110/120/220/230–240 V, 50/60 Hz

### IMPEDANCE SELECTOR switch

#### CAUTION

Do not slide the IMPEDANCE SELECTOR switch while the power of this unit is turned on, as doing so may damage the unit.

Select the switch position (left or right) according to the impedance of the speakers in your system.

Switch position	Impedance level
Right	If you use one set (A or B), the impedance of each speaker must be 8 Ω or higher.
	If you use two sets (A and B), the impedance of each speaker must be 16 Ω or higher.
Left	If you use one set (A or B), the impedance of each speaker must be 4 Ω or higher.
	If you use two sets (A and B), the impedance of each speaker must be 8 Ω or higher.

#### Notes

- The Canada model cannot use two separate speaker sets (A and B) simultaneously when the IMPEDANCE SELECTOR switch is slid to the right position.
- If this unit fails to turn on, the IMPEDANCE SELECTOR switch may not be fully slid to either position. If this is the case, slide the switch all the way to either position when the power supply to this unit is completely cut off.

## Turning on and off this unit

When all connections are complete, turn on the power of this unit.

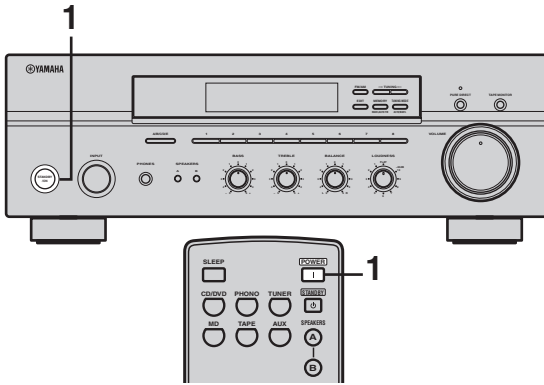

- 1 Press **STANDBY/ON** on the front panel (or **POWER** on the remote control) to turn on this unit.



Front panel

or



Remote control

Press **STANDBY/ON** on the front panel (or **STANDBY** on the remote control) to set this unit to the standby mode.

# PLAYING AND RECORDING

## CAUTION

Extreme caution should be exercised when you play back CDs encoded in DTS.

If you play back a CD encoded in DTS on a DTS-incompatible CD player, you will only hear some unwanted noise that may damage your speakers. Check whether your CD player supports CDs encoded in DTS. Also, check the sound output level of your CD player before you play back a CD encoded in DTS.

## Playing a source

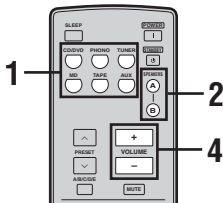
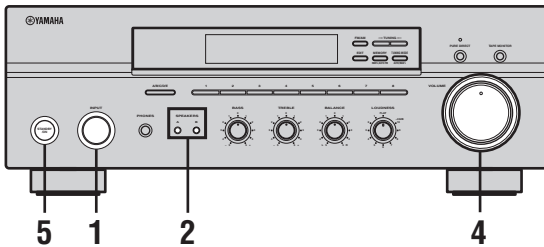

- 1 Rotate the INPUT selector on the front panel (or press one of the input selector buttons on the remote control) to select the desired input source.

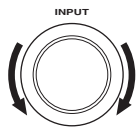

Front panel

or

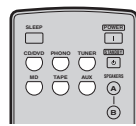

Remote control

## Note

You cannot select any input source while the TAPE MON indicator lights up in the front panel display.

- 2 Press SPEAKERS A and/or SPEAKERS B on the front panel or on the remote control to select speakers A and/or speakers B.

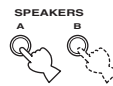

Front panel

or

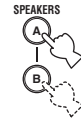

Remote control

## Notes

- Both SPEAKERS A and B can be selected.
- Make sure that the IMPEDANCE SELECTOR switch is correctly set (see page 13).

- 3 Play the source.
- 4 Rotate VOLUME on the front panel (or press VOLUME +/- on the remote control) to adjust the sound output level.

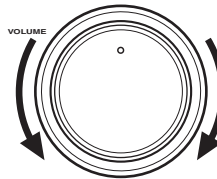

Front panel

or

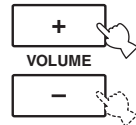

Remote control

- 5 Press STANDBY/ON on the front panel again (or press STANDBY on the remote control) to finish using this unit and set it to the standby mode.



Front panel

or



Remote control

## Adjusting the tonal quality

### ■ Adjusting the BALANCE control

Adjusts the sound output balance of the left and right speakers to compensate for sound imbalance caused by speaker locations or listening room conditions.

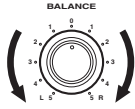

### ■ Using the PURE DIRECT button

Routes input signals from your audio sources so that the input signals bypass the BASS, TREBLE, BALANCE and LOUDNESS controls, thus eliminating any alterations to the audio signals and creating the purest possible sound.



### ■ Adjusting the BASS and TREBLE controls

Adjust the high and low frequency response.

#### BASS

Increases or decreases the low frequency response.

#### TREBLE

Increases or decreases the high frequency response.

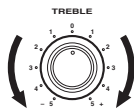
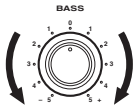

### ■ Adjusting the LOUDNESS control

Retains a full tonal range at any volume level, thus compensating for the human ears' loss of sensitivity to high and low-frequency ranges at a low volume level.

#### CAUTION

If the PURE DIRECT button is turned on with the LOUDNESS control set at a certain level, the input signals bypass the LOUDNESS control, resulting in a sudden increase in the sound output level. To prevent your ears or the speakers from being undesirably damaged, be sure to press the PURE DIRECT button AFTER lowering the sound output level or AFTER checking that the LOUDNESS control is properly set.

- 1 Rotate the LOUDNESS control on the front panel to the FLAT position.

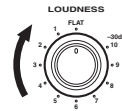

- 2 Rotate VOLUME on the front panel (or press VOLUME +/- on the remote control) to set the sound output level to the loudest listening level that you would listen to.

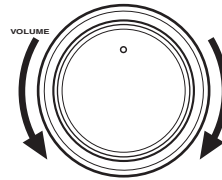

Front panel

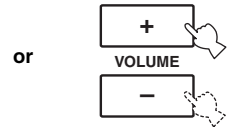

Remote control

- 3 Rotate the LOUDNESS control until the desired volume is obtained.

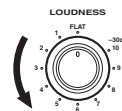

## Recording a source

### Notes

- The VOLUME, BASS, TREBLE, BALANCE and LOUDNESS controls and the PURE DIRECT buttons have no effect on the source being recorded.
- Check the copyright laws in your country to record from records, CDs, radio, etc. Recording copyright-protected material may infringe on copyright laws.

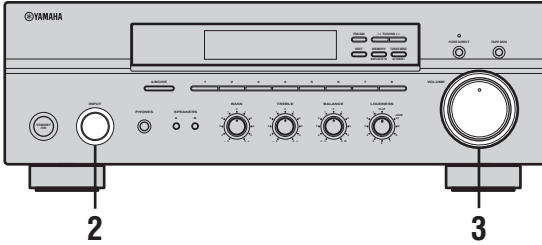

**1** Play the selected source to record from.

**2** Rotate the INPUT selector on the front panel to select the source you want to record from.

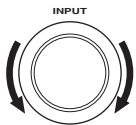

Front panel

or



Remote control

### Note

You cannot select any input source while the TAPE MON indicator lights up in the front panel display.

**3** Rotate VOLUME on the front panel (or press VOLUME +/- on the remote control) to adjust the sound output level of the selected source to record from.

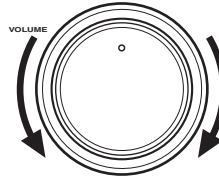

Front panel

or

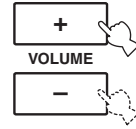

Remote control

**4** Begin recording on the MD recorder, the tape deck or the VCR connected to this unit.



If the 3-head tape deck is used for recording, you can monitor the sound of recording by pressing TAPE MONITOR.

## Using the SLEEP timer

Use this feature to automatically set this unit to the standby mode after a certain amount of time. The SLEEP timer is useful when you are going to sleep while this unit is playing or recording a source. The SLEEP timer also automatically turns off any external components connected to the AC OUTLETS.

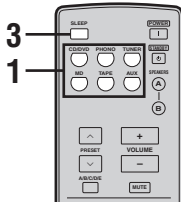

### Note

The SLEEP timer can only be set with the remote control.

- 1 Press one of the input selector buttons on the remote control to select an input source.



- 2 Start playback on the selected input source.

- 3 Press SLEEP repeatedly to set the amount of time before this unit is set to the standby mode.

Each time you press SLEEP, the front panel display changes as shown below.

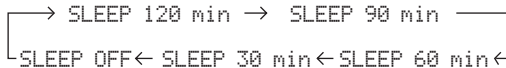

The SLEEP indicator flashes while switching the amount of time for the sleep timer.

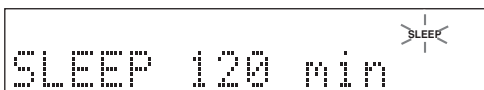

- 4 Press SLEEP repeatedly so that SLEEP OFF appears in the front panel display.



After a few seconds, SLEEP OFF disappears from the front panel display, and the SLEEP indicator turns off.



The sleep timer setting can also be canceled by pressing STANDBY on the remote control (or STANDBY/ON on the front panel) to set this unit to the standby mode.

## Muting the sound output

- 1 Press MUTE on the remote control to mute the sound output.**

The MUTE indicator flashes in the front panel display.



- 2 Press MUTE on the remote control again to resume the sound output.**

The MUTE indicator disappears from the front panel display.



# FM/AM TUNING

There are 2 tuning methods; automatic and manual. Select either method according to your preference and the strength of station signals.

## Automatic tuning

Automatic tuning is effective when station signals are strong and there is no interference.

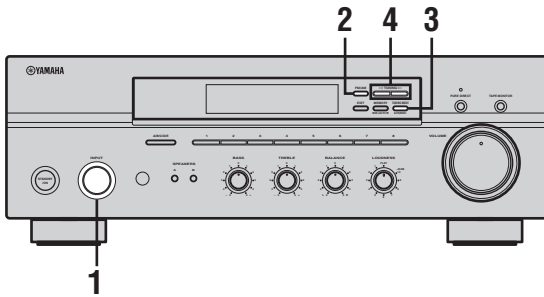

### 4 Press TUNING </> once to begin automatic tuning.

Press > to tune into a higher frequency.

Press < to tune into a lower frequency.

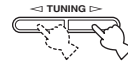

### Notes

- When you tune into a station, the frequency of the received station is shown in the front panel display.
- To search for another station, press TUNING </> once more.
- If the tuning search does not stop at the desired station because the station signals are weak, try using the manual tuning method.

### 1 Rotate the INPUT selector (or press TUNER on the remote control) to select TUNER as the input source.

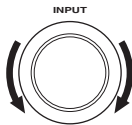

Front panel

or



Remote control

### 2 Press FM/AM on the front panel to select the reception band (FM or AM).

FM or AM appears in the front panel display.



### 3 Press TUNING MODE on the front panel so that the AUTO indicator lights up in the front panel display.



**AUTO**  
Lights up



## Manual tuning

Manual tuning is effective when station signals are weak.

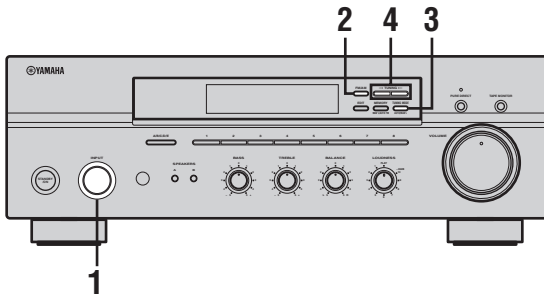

- 1 Rotate the INPUT selector (or press TUNER on the remote control) to select TUNER as the input source.

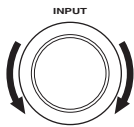

Front panel

or



Remote control

- 2 Press FM/AM on the front panel to select the reception band (FM or AM).

FM or AM appears in the front panel display.



- 3 Press TUNING MODE on the front panel so that the AUTO indicator disappears from the front panel display.



**AUTO**  
Disappears

- 4 Press TUNING <◁/▷> to manually tune into the desired station.

Hold down the button to continue tuning search.



### Notes

- When you tune into a station, the frequency of the received station is shown in the front panel display.
- If you tune into an FM station, it is automatically received in the monaural mode to increase signal quality.

## Automatic preset tuning

You can use the automatic preset tuning method to automatically store FM stations. This function enables this unit to automatically tune into FM stations with strong signals and store up to 40 (8 stations in each of the 5 groups, A1 to E8) of those received stations in order. You can then easily recall any preset stations by selecting the preset station numbers where they are stored.

### Notes

- Any station data stored under a preset station number is cleared when you store a new station under that preset station number.
- If the number of received stations does not reach 40 (E8), automatic preset tuning automatically stops once searching all available stations are tuned into and stored.
- Only FM stations with sufficient signal strength are stored automatically by automatic preset tuning. If the station you want to store is weak in signal strength, try using the manual preset tuning method.

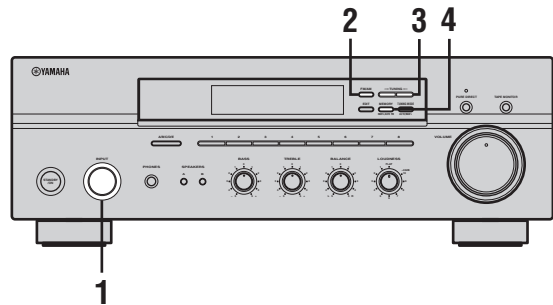

- 1 Rotate the INPUT selector (or press TUNER on the remote control) to select TUNER.

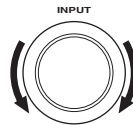

Front panel

or



Remote control

**2 Press FM/AM on the front panel to select FM as the reception band.**

FM appears in the front panel display.



**3 Press and hold MEMORY on the front panel for more than 3 seconds.**

The preset station group and the MEMORY and AUTO indicators flash in the front panel display.



**4 Press TUNING </> once to begin automatic preset tuning.**

Press > to tune into higher frequencies.  
 Press < to tune into lower frequencies.  
 When automatic preset tuning is complete, the frequency of the last preset station is shown in the front panel display.

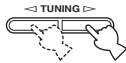

**Notes**

- If TUNING </> is not pressed within approximately 5 seconds while the MEMORY and AUTO indicators are flashing, automatic preset tuning automatically begins from the currently displayed frequency and proceeds toward higher frequencies.
- Received stations are sequentially programmed to 8 stations in each preset station group (A1 to A8). If 8 stations are all programmed in a preset station group, another 8 stations are sequentially programmed in the next preset station group.

**Customized automatic preset tuning**

You can specify a preset station group and a preset station number from which this unit stores the FM stations received by automatic preset tuning.

**1 Press and hold MEMORY on the front panel for more than 3 seconds.**



**2 Press A/B/C/D/E and then press one of the preset station number buttons on the front panel to select the preset station group and the preset station number where the first received station will be stored.**

For example, if you select C5, the first received station is automatically programmed to C5 and the next received stations are sequentially programmed to C6, C7, etc.

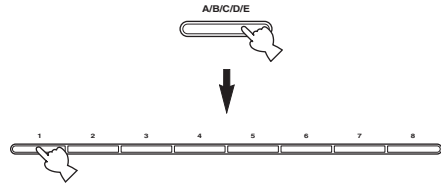

**3 Press TUNING </> on the front panel to begin automatic preset tuning.**

Press > to tune into higher frequencies.  
 Press < to tune into lower frequencies.  
 When automatic preset tuning is complete, the frequency of the last preset station is shown in the front panel display.

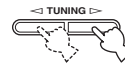

**Note**

Automatic preset tuning stops when the received stations have all been stored up to E8.

## Manual preset tuning

You can also manually store up to 40 stations (8 stations in each of the 5 groups, A1 to E8). You can then easily recall any preset stations by selecting the preset station numbers where they are stored.

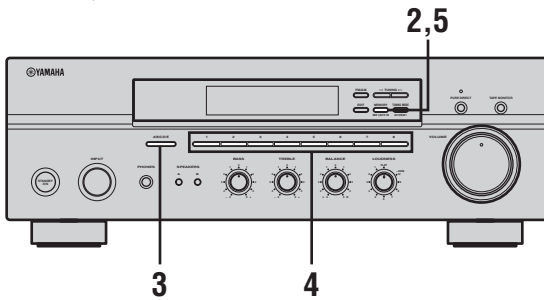

### 1 Repeat steps 1 to 4 in “Automatic tuning” or in “Manual tuning” to tune into a station.

When you tune into a station, the frequency of the received station is shown in the front panel display.

### 2 Press MEMORY on the front panel.

The MEMORY indicator flashes in the front panel display for approximately 5 seconds.



**MEMORY  
Flashes**

### 3 Press A/B/C/D/E on the front panel repeatedly to select a preset station group (A to E).

The selected preset station group is shown in the front panel display.

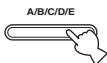

### 4 Press one of the preset station number buttons on the front panel to select a preset station number (1 to 8) where you want to store the station.

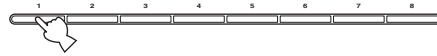

#### Note

This operation must be done within 5 seconds while the MEMORY indicator is flashing in the front panel display. Otherwise, the manual preset tuning process is automatically canceled.

### 5 Press MEMORY on the front panel to store the station.

### 6 Repeat steps 1 to 5 to store other stations.

#### Notes

- Any station data stored under a preset station number is cleared when you store a new station under that preset station number.
- The reception mode (stereo or monaural) is stored along with the station frequency.

## Selecting preset stations

You can tune into the desired station simply by selecting the preset station number where it is stored.

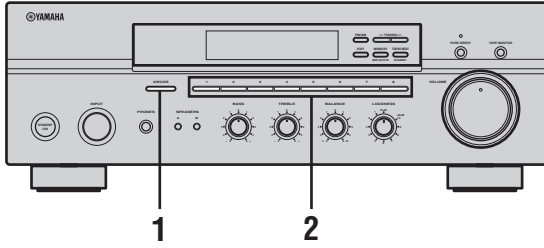

- 1 Press **A/B/C/D/E** on the front panel repeatedly (or on the remote control) to select a preset station group (A to E). The selected preset station group is shown in the front panel display.

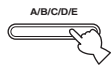

Front panel

or



Remote control

- 2 Press one of the preset station number buttons on the front panel (or **PRESET ^ / v** on the remote control) to select a preset station number (1 to 8). The preset station number appears in the front panel display along with the reception band and the frequency.

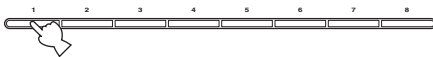

Front panel

or

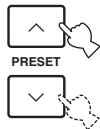

Remote control

## Exchanging preset stations

You can exchange the assignment of two preset stations with each other. The following procedure describes an example where a preset station E1 is exchanged with another preset station A5.

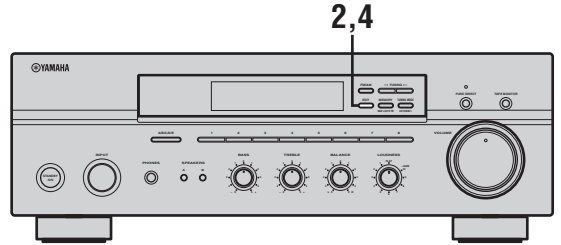

- 1 Repeat steps 1 and 2 in “Selecting preset stations” to select a preset station E1.

- 2 Press **EDIT** on the front panel. E1 and the MEMORY indicator flash in the front panel display.



MEMORY  
Flashes

- 3 Repeat steps 1 and 2 in “Selecting preset stations” to select another preset station A5. A5 and the MEMORY indicator flash in the front panel display.

MEMORY  
Flashes

- 4 Press **EDIT** on the front panel again. E1-A5 appears in the front panel display, indicating that the two preset station assignments have been exchanged.



# ADVANCED SETUP

## ■ ADVANCED SETUP menu parameters

Change the initial settings (indicated in bold under each parameter) to reflect the needs of your listening environment.

### Factory presets PRESET

Use to reset all parameters to the factory presets.

Choices: **CANCEL**, RESET

- Select **CANCEL** if you do not want the parameters of this unit to be initialized when you reset the factory presets.
- Select **RESET** if you want all of the parameters of this unit to be initialized when you reset the factory presets.

### Notes

- This setting does not affect the parameters in the ADVANCED SETUP menu.
- The resetting process starts next time you turn on the power of this unit.

### Tuner TU

#### (Asia and General models only)

Use to switch the frequency step selection according to the frequency spacing in your area.

Choices: **AM10/FM100**, AM9/FM50

- North, Central and South America: **AM10/FM100** (kHz)
- Other areas: AM9/FM50 (kHz)

## Changing the ADVANCED SETUP menu parameters

The ADVANCED SETUP menu is displayed in the front panel display.



- During the ADVANCED SETUP procedure, audio output is muted.
- During the ADVANCED SETUP procedure, only **STANDBY/ON**, **A/B/C/D/E** and the preset station number buttons (1 and 2) on the front panel are operational.

### CAUTION

Be sure to set the speaker impedance before using this unit to play back audio signals (see page 13).

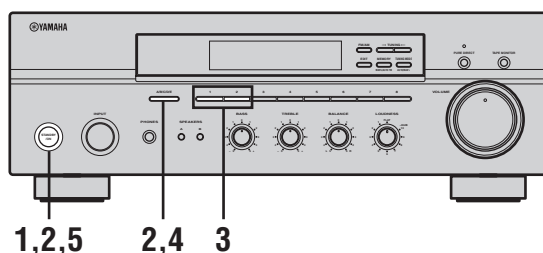

- 1 Press STANDBY/ON on the front panel to set this unit to the standby mode.**



- 2 Press and hold A/B/C/D/E on the front panel and then press STANDBY/ON.**

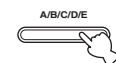

**While holding down, press**



- 
- 3 (Asia and General models only)**  
Press the preset station number buttons (1 and 2) on the front panel to move through the menu and select the parameter you want to adjust.

See page 25 for available parameters.

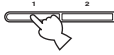

- 
- 4** Press A/B/C/D/E on the front panel repeatedly to toggle between the available parameters.

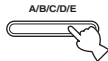

- 
- 5** Press STANDBY/ON to confirm your setting.



**Note**

The settings you made are reflected next time you turn on this unit.

# TROUBLESHOOTING

Refer to the chart below if this unit does not function properly. If the problem you are experiencing is not listed below or if the instructions below do not help, set this unit to the standby mode, disconnect the power cord, and contact the nearest authorized YAMAHA dealer or service center.

## ■ General

Problem	Cause	Remedy	See page
<b>This unit fails to turn on.</b>	The power supply cord is not connected or the plug is not completely inserted.	Connect the power supply cord firmly.	—
	The impedance setting is incorrect.	Set the impedance to match your speakers.	13
	The protection circuitry has been activated because of a short circuit, etc.	Check that the speaker wires are not touching each other and then turn the power of this unit back on.	10
	The IMPEDANCE SELECTOR switch on the rear panel is not set to either end.	Set the IMPEDANCE SELECTOR switch to either end when the power of this unit is turned off.	13
	This unit has been exposed to a strong external electric shock (such as lightning or strong static electricity).	Set this unit to the standby mode, disconnect the power supply cord, plug it back in after 30 seconds, then use it normally.	—
<b>No sound</b>	Incorrect input or output cable connections.	Connect the cables properly. If the problem persists, the cables may be defective.	9
	No appropriate input source has been selected.	Select an appropriate input source with the INPUT selector on the front panel (or one of the input selector buttons on the remote control).	15
	The TAPE MONITOR function is turned on.	Turn off the TAPE MONITOR function.	3
	The SPEAKERS A/B switches are not set properly.	Turn on the corresponding SPEAKERS A or SPEAKERS B.	15
	Speaker connections are not secure.	Secure the connections.	10
<b>The sound suddenly goes off.</b>	The protection circuitry has been activated because of a short circuit, etc.	Check that the IMPEDANCE SELECTOR setting is correct.	13
		Check that the speaker wires are not touching each other and then turn the power of this unit back on.	10
<b>Only the speaker on one side can be heard.</b>	Incorrect cable connections.	Connect the cables properly. If the problem persists, the cables may be defective.	9
	Incorrect setting for the BALANCE control.	Set the BALANCE control to the appropriate position.	16
<b>There is a lack of bass and no ambience.</b>	The + and – wires are connected in reverse at the amplifier or the speakers.	Connect the speaker wires to the correct + and – phase.	10
<b>A “humming” sound can be heard.</b>	Incorrect cable connections.	Connect the audio plugs firmly. If the problem persists, the cables may be defective.	9
	No connection from the turntable to the GND terminal.	Make the GND connection between the turntable and this unit.	9
<b>The volume level is low while playing a record.</b>	The record is being played on a turntable with an MC cartridge.	The turntable should be connected to this unit through the MC head amplifier.	—
<b>The volume level cannot be increased, or the sound is distorted.</b>	The component connected to the TAPE OUT or the MD OUT jacks of this unit is turned off.	Turn on the power of the component.	—

<b>The sound is degraded when listening with the headphones connected to the CD player or the tape deck connected to this unit.</b>	The power of this unit is turned off, or this unit is set to the standby mode.	Turn on the power of this unit.	14
<b>The sound level is low.</b>	The LOUDNESS control is functioning.	Set the LOUDNESS control to the FLAT position.	16
<b>The INPUT selector will not function though it is rotated.</b>	The TAPE MONITOR function is turned on.	Turn off the TAPE MONITOR function.	3
<b>Using the BASS, TREBLE, BALANCE and LOUDNESS controls does not affect the tonal quality.</b>	The PURE DIRECT button is turned on.	The PURE DIRECT button must be turned off to use those controls.	16

■ **Tuner**

<b>Problem</b>		<b>Cause</b>	<b>Remedy</b>	<b>See page</b>
<b>FM</b>	<b>FM stereo reception is noisy.</b>	The particular characteristics of the FM stereo broadcasts being received may cause this problem when the transmitter is too far away or the antenna input is poor.	Check the antenna connections. Try using a high-quality directional FM antenna.	11
			Try using the manual tuning method.	21
	<b>There is distortion, and clear reception cannot be obtained even with a good FM antenna.</b>	There is multipath interference.	Adjust the antenna position to eliminate the multipath interference.	—
	<b>The desired station cannot be tuned in with the automatic tuning method.</b>	The signal is too weak.	Try using a high-quality directional FM antenna.	11
			Try using the manual tuning method.	21
<b>Previously preset stations can no longer be tuned in.</b>	This unit has been disconnected for a long period.	Preset the stations again.	21	
<b>AM</b>	<b>The desired station cannot be tuned in with the automatic tuning method.</b>	The signal is weak or the antenna connections are loose.	Tighten the AM loop antenna connections and orient it for the best reception.	—
			Try using the manual tuning method.	21
	<b>There are continuous crackling and hissing noises.</b>	The noises may result from lightning, fluorescent lamps, motors, thermostats or other electrical equipment.	Try using an outdoor antenna and a ground wire. This will help somewhat, but it is difficult to eliminate all noise.	—
	<b>There are buzzing and whining noises.</b>	A TV set is being used nearby.	Move this unit away from the TV set.	—



## ■ Remote control

Problem	Cause	Remedy	See page
<b>The remote control does not work nor function properly.</b>	Wrong distance or angle.	The remote control will function within a maximum range of 6 m (19.7 ft) and no more than 30 degrees off-axis from the front panel.	8
	Direct sunlight or lighting (from an inverter type of fluorescent lamp, etc.) is striking the remote control sensor of this unit.	Reposition this unit.	—
	The batteries are weak.	Replace all batteries.	8

# SPECIFICATIONS

## AUDIO SECTION

- Minimum RMS Output Power  
(8 Ω, 20 Hz to 20 kHz, 0.04% THD) ..... 50 W + 50 W
- Dynamic Power (IHF)  
(8/6/4/2 Ω) ..... 70/77/89/100 W
- Maximum Output Power [Europe model only]  
(1 kHz, 0.7% THD, 4 Ω) ..... 55 W
- IEC Output Power [Europe model only]  
(1 kHz, 0.04% THD, 8 Ω) ..... 52 W
- Power Band Width  
(0.08% THD, 25 W, 8 Ω) ..... 10 Hz to 50 kHz
- Damping Factor (SPEAKERS A)  
20 Hz to 20 kHz, 8 Ω ..... 150 or more
- Maximum Output Power (EIAJ)  
[Asia and General models only]  
(1 kHz, 10% THD, 8 Ω) ..... 85 W
- Maximum Input Signal  
PHONO (1 kHz, 0.04% THD) ..... 115 mV or more  
CD/DVD, etc. (1 kHz, 0.04% THD) ..... 2.2 V or more
- Frequency Response  
CD/DVD, etc. (20 Hz to 20 kHz) ..... 0 ± 0.5 dB  
CD/DVD, etc.  
PURE DIRECT ON (10 Hz to 100 kHz) ..... 0 ± 1.0 dB
- RIAA Equalization Deviation  
PHONO ..... ± 0.5 dB
- Total Harmonic Distortion  
PHONO to OUT (REC)  
(20 Hz to 20 kHz, 3 V) ..... 0.02% or less  
CD/DVD, etc. to SPEAKERS  
(20 Hz to 20 kHz, 25 W, 8 Ω) ..... 0.02% or less
- Signal to Noise Ratio (IHF-A Network)  
PHONO (5 mV input shorted) ..... 82 dB or more  
CD/DVD, etc. (150 mV input shorted) ..... 108 dB or more
- Residual Noise (IHF-A Network)  
PURE DIRECT ON ..... 100 μV
- Input Sensitivity/Input Impedance  
PHONO ..... 2.5 mV/47 kΩ  
CD/DVD, etc. .... 150 mV/47 kΩ
- Output Level/Output Impedance  
OUT (REC) ..... 150 mV/1.2 kΩ or less
- Headphone Output/Impedance  
(Input 1 kHz, 150 mV, 8 Ω, 0.04% THD)  
CD/DVD, etc. .... 0.47 V/330 Ω
- Channel Separation  
CD/DVD, etc. (5.1 kΩ input shorted, 1/10 kHz) ..... 65/50 dB or more
- Tone Control Characteristics  
BASS  
Boost/Cut (50 Hz) ..... ±10 dB  
Turnover Frequency ..... 350 Hz  
TREBLE  
Boost/Cut (20 kHz) ..... ±10 dB  
Turnover Frequency ..... 3.5 kHz
- Continuous Loudness Control  
Attenuation (1 kHz) ..... -30 dB

## FM SECTION

- Tuning Range  
[U.S.A. and Canada models] ..... 87.5 to 107.9 MHz  
[Asia and General models] ..... 87.5/87.50 to 107.9/108.00 MHz  
[Other models] ..... 87.50 to 108.00 MHz
- Usable Sensitivity (IHF) ..... 1.0 μV (11.2 dBf)
- Signal to Noise Ratio (IHF)  
Mono/Stereo ..... 76 dB/70 dB
- Harmonic Distortion (1 kHz)  
Mono/Stereo ..... 0.2%/0.3%
- Stereo Separation (1 kHz) ..... 45 dB
- Frequency Response ..... 20 Hz to 15 kHz, +0.5/-2 dB

## AM SECTION

- Tuning Range  
[U.S.A. and Canada models] ..... 530 to 1710 kHz  
[Asia and General models] ..... 530/531 to 1710/1611 kHz  
[Other models] ..... 531 to 1611 kHz
- Usable Sensitivity ..... 300 μV/m

## GENERAL

- Power Supply  
[U.S.A. and Canada models] ..... AC 120 V, 60 Hz  
[Asia model] ..... AC 220/230-240 V, 50/60 Hz  
[General model] ..... AC 110/120/220/230-240 V, 50/60 Hz  
[Australia model] ..... AC 240 V, 50 Hz  
[Europe model] ..... AC 230 V, 50 Hz
- Power Consumption ..... 130 W
- Standby Power Consumption ..... 0.1 W or less
- Maximum Power Consumption [General model only]  
(8 Ω, 1 kHz, 10% THD) ..... 300 W
- AC Outlets  
[Australia model] ..... 1 (Total 100 W maximum)  
[General model] ..... 2 (Total 50 W maximum)  
[Other models] ..... 2 (Total 100 W maximum)
- Dimensions (W x H x D) ..... 435 x 151 x 308 mm  
(17-1/8" x 5-15/16" x 12-1/8")
- Weight ..... 7.4 kg (16 lbs. 5 oz.)

\* Specifications are subject to change without notice.mm



This product mainly uses lead-free solder.

© 2005 YAMAHA CORPORATION All rights reserved.

**YAMAHA ELECTRONICS CORPORATION, USA** 6660 ORANGETHORPE AVE., BUENA PARK, CALIF. 90620, U.S.A.  
**YAMAHA CANADA MUSIC LTD.** 135 MILNER AVE., SCARBOROUGH, ONTARIO M1S 3R1, CANADA  
**YAMAHA ELECTRONIK EUROPA G.m.b.H.** SIEMENSSTR. 22-34, 25462 RELLINGEN BEI HAMBURG, GERMANY  
**YAMAHA ELECTRONIQUE FRANCE S.A.** RUE AMBROISE CROIZAT BP70 CROISSY-BEAUBOURG 77312 MARNE-LA-VALLEE CEDEX02, FRANCE  
**YAMAHA ELECTRONICS (UK) LTD.** YAMAHA HOUSE, 200 RICKMANSWORTH ROAD WATFORD, HERTS WD18 7GQ, ENGLAND  
**YAMAHA SCANDINAVIA A.B.** J A WETTERGRENS GATA 1, BOX 30053, 400 43 VÄSTRA FRÖLUNDA, SWEDEN  
**YAMAHA MUSIC AUSTRALIA PTY, LTD.** 17-33 MARKET ST., SOUTH MELBOURNE, 3205 VIC., AUSTRALIA

**YAMAHA CORPORATION**  
Printed in Malaysia ◀ WG05070

Read the following instructions instead of “IMPORTANT SAFETY INSTRUCTIONS” (1 to 14 on page i) on the OWNER’S MANUAL.

## IMPORTANT SAFETY INSTRUCTIONS

- 1 Read Instructions – All the safety and operating instructions should be read before the product is operated.
- 2 Retain Instructions – The safety and operating instructions should be retained for future reference.
- 3 Heed Warnings – All warnings on the product and in the operating instructions should be adhered to.
- 4 Follow Instructions – All operating and use instructions should be followed.
- 5 Cleaning – Unplug this product from the wall outlet before cleaning. Do not use liquid cleaners or aerosol cleaners.
- 6 Attachments – Do not use attachments not recommended by the product manufacturer as they may cause hazards.
- 7 Water and Moisture – Do not use this product near water – for example, near a bath tub, wash bowl, kitchen sink, or laundry tub; in a wet basement; or near a swimming pool; and the like.
- 8 Accessories – Do not place this product on an unstable cart, stand, tripod, bracket, or table. The product may fall, causing serious injury to a child or adult, and serious damage to the product. Use only with a cart, stand, tripod, bracket, or table recommended by the manufacturer, or sold with the product. Any mounting of the product should follow the manufacturer’s instructions, and should use a mounting accessory recommended by the manufacturer.
- 9 A product and cart combination should be moved with care. Quick stops, excessive force, and uneven surfaces may cause the product and cart combination to overturn. 
- 10 Ventilation – Slots and openings in the cabinet are provided for ventilation and to ensure reliable operation of the product and to protect it from overheating, and these openings must not be blocked or covered. The openings should never be blocked by placing the product on a bed, sofa, rug, or other similar surface. This product should not be placed in a built-in installation such as a bookcase or rack unless proper ventilation is provided or the manufacturer’s instructions have been adhered to.
- 11 Power Sources – This product should be operated only from the type of power source indicated on the marking label. If you are not sure of the type of power supply to your home, consult your product dealer or local power company. For products intended to operate from battery power, or other sources, refer to the operating instructions.
- 12 Grounding or Polarization – This product may be equipped with a polarized alternating current line plug (a plug having one blade wider than the other). This plug will fit into the power outlet only one way. This is a safety feature. If you are unable to insert the plug fully into the outlet, try reversing the plug. If the plug should still fail to fit, contact your electrician to replace your obsolete outlet. Do not defeat the safety purpose of the polarized plug.
- 13 Power-Cord Protection – Power-supply cords should be routed so that they are not likely to be walked on or pinched by items placed upon or against them, paying particular attention to cords at plugs, convenience receptacles, and the point where they exit from the product.
- 14 Lightning – For added protection for this product during a lightning storm, or when it is left unattended and unused for long periods of time, unplug it from the wall outlet and disconnect the antenna or cable system. This will prevent damage to the product due to lightning and power-line surges.
- 15 Power Lines – An outside antenna system should not be located in the vicinity of overhead power lines or other electric light or power circuits, or where it can fall into such power lines or circuits. When installing an outside antenna system, extreme care should be taken to keep from touching such power lines or circuits as contact with them might be fatal.
- 16 Overloading – Do not overload wall outlets, extension cords, or integral convenience receptacles as this can result in a risk of fire or electric shock.
- 17 Object and Liquid Entry – Never push objects of any kind into this product through openings as they may touch dangerous voltage points or short-out parts that could result in a fire or electric shock. Never spill liquid of any kind on the product.
- 18 Servicing – Do not attempt to service this product yourself as opening or removing covers may expose you to dangerous voltage or other hazards. Refer all servicing to qualified service personnel.
- 19 Damage Requiring Service – Unplug this product from the wall outlet and refer servicing to qualified service personnel under the following conditions:
  - a) When the power-supply cord or plug is damaged,
  - b) If liquid has been spilled, or objects have fallen into the product,
  - c) If the product has been exposed to rain or water,
  - d) If the product does not operate normally by following the operating instructions. Adjust only those controls that are covered by the operating instructions as an improper adjustment of other controls may result in damage and will often require extensive work by a qualified technician to restore the product to its normal operation,
  - e) If the product has been dropped or damaged in any way, and
  - f) When the product exhibits a distinct change in performance - this indicates a need for service.

- 20 Replacement Parts** – When replacement parts are required, be sure the service technician has used replacement parts specified by the manufacturer or have the same characteristics as the original part. Unauthorized substitutions may result in fire, electric shock, or other hazards.
- 21 Safety Check** – Upon completion of any service or repairs to this product, ask the service technician to perform safety checks to determine that the product is in proper operating condition.
- 22 Wall or Ceiling Mounting** – The unit should be mounted to a wall or ceiling only as recommended by the manufacturer.
- 23 Heat** – The product should be situated away from heat sources such as radiators, heat registers, stoves, or other products (including amplifiers) that produce heat.
- 24 Outdoor Antenna Grounding** – If an outside antenna or cable system is connected to the product, be sure the antenna or cable system is grounded so as to provide some protection against voltage surges and built-up static charges. Article 810 of the National Electrical Code, ANSI/NFPA 70, provides information with regard to proper grounding of the mast and supporting structure, grounding of the lead-in wire to an antenna discharge unit, size of grounding conductors, location of antenna discharge unit, connection to grounding electrodes, and requirements for the grounding electrode.

EXAMPLE OF ANTENNA GROUNDING

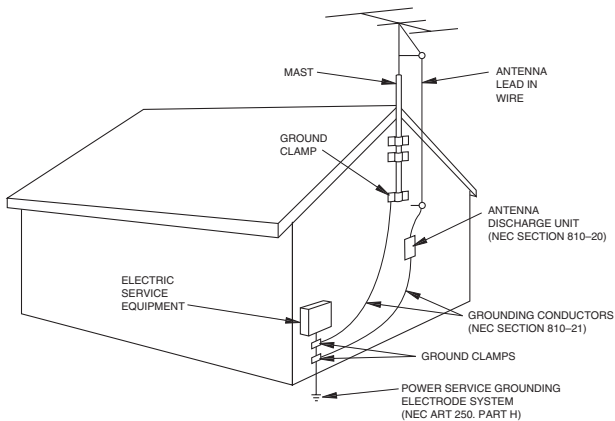

NEC – NATIONAL ELECTRICAL CODE